

## Pressure transmitter for general industrial applications Model A-10

WIKA Data Sheet PE 81.60



### Applications

- Mechanical engineering
- Machine tools
- Control and feedback control systems
- Hydraulics / Pneumatics
- Pumps/ Compressors

### Special Features

- Pressure ranges: from 0 ... 1 bar up to 0 ... 600 bar
- Non-linearity: 0.25 % or 0.5 %
- Signal output: 4 ... 20 mA, 0 ... 10 V, 0 ... 5 V and other
- Electrical connection: DIN 175301-803 A and C, M12x1, Flying leads 2m
- Pressure connection: G1/4 DIN 3852-E, 1/4 NPT and others



Pressure transmitter A-10

## Description

### Simple - reliable – competitive

The WIKA A-10 can be used for a multitude of functions across many different applications. Exceptionally simple installation, set-up and operation with an excellent price/performance ratio set this highly-reliable product apart.

# Specifications

# Model A-10

Pressure ranges	bar	1	1.6	2,5	4	6	10	16	25
Over pressure safety	bar	2	3.2	5	8	12	20	32	50
Burst pressure	bar	5	10	10	17	34	34	100	100
Pressure ranges	bar	40	60	100	160	250	400	600	
Over pressure safety	bar	80	120	200	320	500	800	1200	
Burst pressure	bar	400	550	800	1000	1200	1700	2400	
MPa and kg/cm <sup>2</sup> are available									
{Absolute pressure: 0 ... 1 bar up to 0 ... 25 bar}									
Pressure ranges	psi	15	25	30	50	100	160	200	300
Over pressure safety	psi	30	60	60	100	200	290	400	600
Burst pressure	psi	75	150	150	250	500	500	1500	1500
Pressure ranges	psi	500	1000	1500	2000	3000	5000	10000	
Over pressure safety	psi	1000	1740	2900	4000	6000	10000	17400	
Burst pressure	psi	2500	7975	11600	14500	17400	24650	34800	
{Absolute pressure: 0 ... 15 psi up to 0 ... 300 psi}.									
Vacuum resistance		As of 0 ... 10 bar							
Fatigue life		10 Mio. max. load cycles							
Materials									
■ Wetted parts									
» Pressure Connection		316 L							
» Pressure sensor		316 L (as of 0 ... 10 bar rel 13-8 PH)							
■ Internal transmission fluid		Silicone oil (only with pressure ranges < 0 ... 10 bar and ≤ 0 ... 25 bar abs)							
■ Case		316 L							
Power supply UB	UB in VDC	8 ... 30 {8 ... 36 <sup>1)</sup> }							
maximum ohmic load R <sub>A</sub>		14 ... 30 {14 ... 36} with signal output 0 ... 10 V							
		5 ± 10 % with signal output 0,5 ... 4,5 V ratiometric							
		<sup>1)</sup> not with non-linearity 0.25 % BFSL and 4 ... 20 mA							
Signal output and	R <sub>A</sub> in Ohm	4 ... 20 mA, 2-wire				R <sub>A</sub> ≤ (UB - 8 V) / 0.02 A			
maximum ohmic load R <sub>A</sub>		0 ... 10 V, 3-wire				R <sub>A</sub> > 10 k			
		0 ... 5 V, 3-wire				R <sub>A</sub> > 5 k			
		1 ... 5 V, 3-wire				R <sub>A</sub> > 5 k			
		0.5 ... 4.5 V, 3-wire				R <sub>A</sub> > 4.5 k			
		0.5 ... 4.5 V, ratiometric				R <sub>A</sub> > 4.5 k {other signal outputs on request}			
Setting time	ms	< 4							
Current consumption	mA	Signal current (max. 25) for current output							
		Max. 8 for voltage output signal							
Insulation voltage	VDC	500 <sup>2)</sup>							
		<sup>2)</sup> For power supply, use a circuit with energy limitation (EN/UL/IEC 61010-1, section 9.3) with the following maximum values for the current: bei UB = 30 V (DC): 5 A. Provide a separate switch for the external power supply.							
		Alternative for North America: The connection may also be made to „Class 2 Circuits“ or „Class 2 Power Units“ according to CEC (Canadian Electrical Code) or NEC (National Electrical Code).							
Non-linearity	% of span	≤ ± 0.25				(BFSL) according to IEC 61298-2			
		≤ ± 0.5				(BFSL) according to IEC 61298-2			
		Adjusted in vertical mounting position with lower pressure connection							
Accuracy <sup>3)</sup>	% of span	≤ ± 0.5				(with non-linearity 0.25 %)			
		≤ ± 0.6				(with non-linearity 0.25 % and with signal output 0 ... 5 V)			
		≤ ± 1.0				(with non-linearity 0.5 %)			
		<sup>3)</sup> Including non-linearity, hysteresis, zero point and full scale error (corresponds to error of measurement per IEC 61298-2)							
Zero offset	% of span	≤ 0.15 typ., ≤ 0.4 max.				(with non-linearity 0.25 %)			
		≤ 0.5 typ., ≤ 0.8 max.				(with non-linearity 0.5 %)			
Hysteresis	% of span	≤ 0.16							
Non-repeatability	% of span	≤ 0.1							
Long-term drift	% of span	≤ 0.1 according to IEC 61298-2							
Signal noise	% of span	≤ 0.3							

# Specifications

# Model A-10

Permissible temperature of			
■ Medium		0 ... +80 °C {-30 ... +100 °C}	+32 ... +176 °F {-22 ... +212 °F}
■ Ambience		0 ... +80 °C {-30 ... +100 °C}	+32 ... +176 °F {-22 ... +212 °F}
■ Storage		-20 ... +80 °C {-30 ... +100 °C}	-4 ... +176 °F {-22 ... +212 °F}
Rated temperature range		0 ... +80 °C	+32 ... +176 °F
Temperature error within rated temperature range	% of span	≤ 1.0 typ., ≤ 2.5 max.	
Approvals		UL, CSA, GOST	
RoHS-conformity		Yes	
CE-conformity			
■ Pressure equipment directive		97/23/EC	
■ EMC directive		89/336/EEC emission (class B) and immunity according to EN 61 326	
Shock resistance	g	500 according to IEC 60068-2-27 (mechanical shock)	
Vibration resistance	g	10 according to IEC 60068-2-6 (vibration under resonance) {20 g on request}	
Wiring protection			
■ Overvoltage protection	VDC	32; 36 with 4 ... 20 mA	
■ Short-circuit proofness		S+ towards UB-	
■ Reverse polarity protection		UB+ towards UB-	
Reference conditions		According to IEC 61298-1	
■ Relative humidity	%	45 ... 75	
Weight	g	Approx. 80	

{ } Items in curved brackets are optional extras for additional price.

## Dimensions in mm

Ingress protection IP per IEC 60529. The ingress protection classes specified only apply while the pressure transmitter is connected with female connectors that provide the corresponding ingress protection.

DIN 175301-803 A  
L-connector  
for conductor cross section up to max. 1.5 mm<sup>2</sup>,  
conductor outer diameter 6-8 mm, IP 65

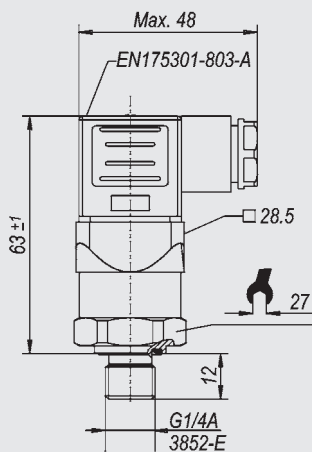

DIN 175301-803 C  
L-connector  
for conductor cross section up to max. 0.75 mm<sup>2</sup>,  
conductor outer diameter 4.5-6 mm, IP 65

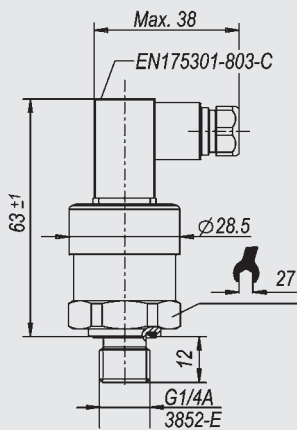

M 12x1, 4-pin  
IP 67

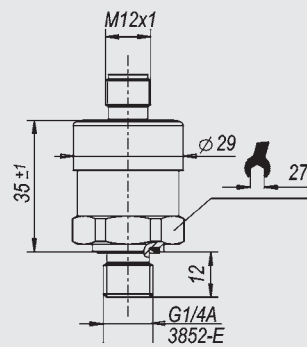

Flying leads,  
conductor cross section 3x 0.34 mm<sup>2</sup>,  
conductor outer diameter 6.6 mm,  
PUR cable - unshielded, IP 67

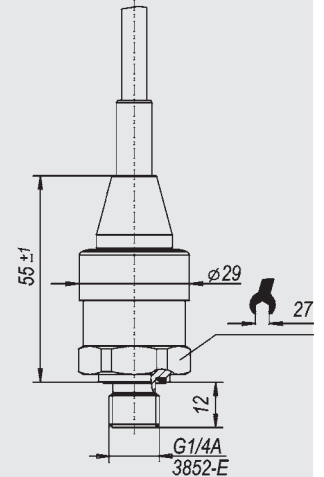

For tapped holes and welding sockets please see Technical Information IN 00.14 for download at [www.wika.de](http://www.wika.de)

## Pressure connections

Pressure port (0.3 or 0.6 mm) and extended pressure port on request

G 1/4  
DIN 3852-E  
with sealing NBR {FKM}  
Over pressure safety max. 600 bar

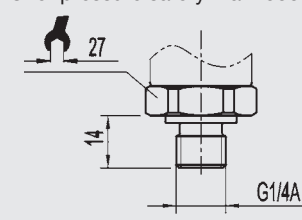

G 1/4  
EN 837  
with sealing  
Copper {Stainless steel}

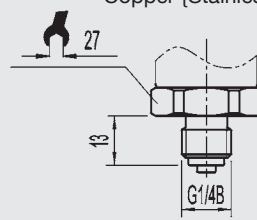

G 1/4 female  
EN 837  
with sealing  
Copper {Stainless steel}

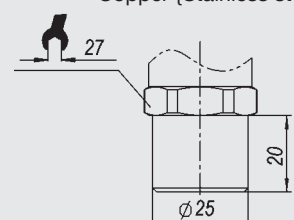

## Pressure connections

1/4 NPT

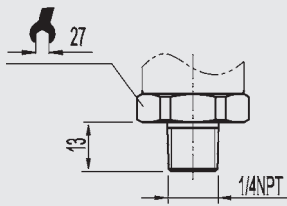

1/4 NPT female

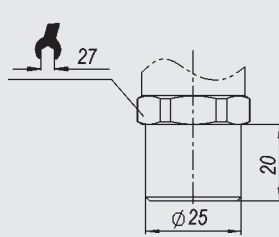

M 20 x 1,5  
with sealing  
Copper {Stainless steel}

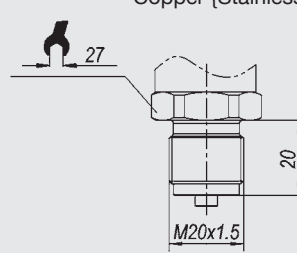

R 1/4 ISO 7

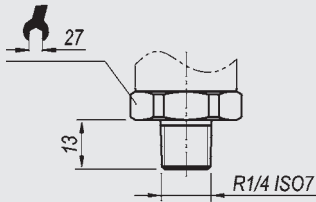

PT 1/4

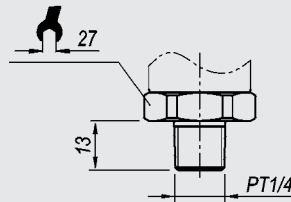

7/16-20 UNF  
with Boss O-ring FKM  
max. permitted temperature  
-10 ... +100 °C

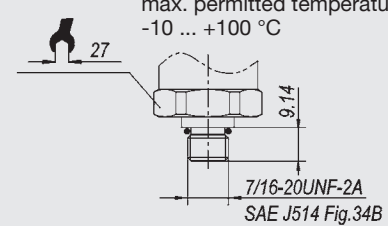

## Electrical connections

2-wire

3-wire

DIN 175301-803 A  
L-connector

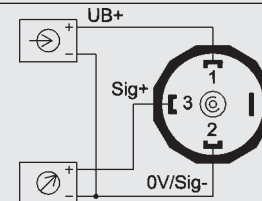
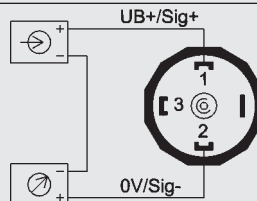

DIN 175301-803 C  
L-connector

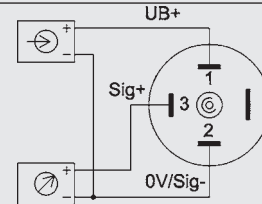
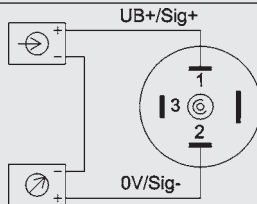

M 12x1, 4-pin  
without angle socket or  
female cable connectors

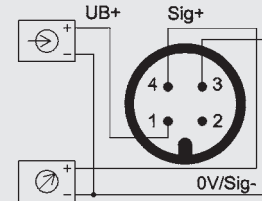
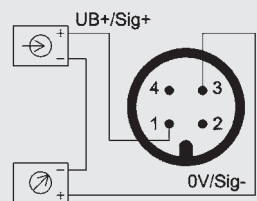

Flying leads

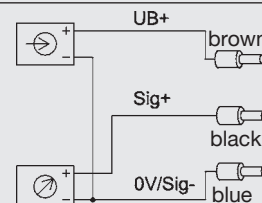
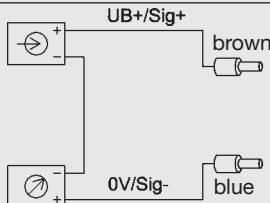

 power supply

 load (e.g. display)

Specifications and dimensions given in this leaflet represent the state of engineering at the time of printing. Modifications may take place and materials specified may be replaced by others without prior notice.