



PROGRAMMABLE LED INDICATOR PREVIEW 5714

TABLE OF CONTENTS

Warnings	24
Safety instructions.....	25
Declaration of Conformity	27
Front and back layout	28
Applications.....	29
Technical characteristics	29
Mounting	29
Applications.....	30
Order	31
Electrical specifications.....	29
Sensor error detection	35
Connections	36
Block diagram	37
Routing diagram.....	38
Scrolling help text	40
Configuration / operating the function keys	42
Graphic depiction of the relay function setpoint	43

5 7 1 4

**Programmable
LED Indicator**

No. 5714V102-IN (1022)
From ser. no. 060137001



SIGNALS THE BEST



GENERAL

WARNING!

This module is designed for connection to hazardous electric voltages. Ignoring this warning can result in severe personal injury or mechanical damage. To avoid the risk of electric shock and fire, the safety instructions of this manual must be observed and the guidelines followed. The specifications must not be exceeded, and the module must only be applied as described in the following. Prior to the commissioning of the module, this manual must be examined carefully. Only qualified personnel (technicians) should install this module.

If the equipment is used in a manner not specified by the manufacturer, the protection provided by the equipment may be impaired.



**HAZARD-
OUS
VOLTAGE**

WARNING!

Until the module is fixed, do not connect hazardous voltages to the module.

The following operations should only be carried out on a disconnected module and under ESD safe conditions:
Troubleshooting the module.

Repair of the module must be done by PR electronics A/S only.



SYMBOL IDENTIFICATION



Triangle with an exclamation mark: Warning / demand. Potentially lethal situations.



The CE mark proves the compliance of the module with the essential requirements of the directives.

SAFETY INSTRUCTIONS

DEFINITIONS:

Hazardous voltages have been defined as the ranges: 75 to 1500 Volt DC, and 50 to 1000 Volt AC.

Technicians are qualified persons educated or trained to mount, operate, and also troubleshoot technically correct and in accordance with safety regulations. Operators, being familiar with the contents of this manual, adjust and operate the knobs or potentiometers during normal operation.

RECEIPT AND UNPACKING:

Unpack the device without damaging it. The packing should always follow the device until this has been permanently mounted. Check at the receipt of the device whether the type corresponds to the one ordered.

ENVIRONMENT:

Avoid direct sunlight, dust, high temperatures, mechanical vibrations and shock, as well as rain and heavy moisture. If necessary, heating in excess of the stated limits for ambient temperatures should be avoided by way of ventilation.

All modules fall under Installation Category II, Pollution Degree 1, and Insulation Class II.

MOUNTING:

Only technicians who are familiar with the technical terms, warnings, and instructions in the manual and who are able to follow these should connect the module.

Should there be any doubt as to the correct handling of the module, please contact your local distributor or, alternatively,

***PR electronics A/S, Lerbakken 10, DK-8410 Rønde, Denmark,
tel: +45 86 37 26 77.***

Mounting and connection of the module should comply with national legislation for mounting of electric materials, i.a. wire cross section, protective fuse, and location. Descriptions of Input / Output and supply connections are shown in the block diagram and side label.

The following apply to fixed hazardous voltages-connected modules:

The max. size of the protective fuse is 10 A and, together with a power switch, it should be easily accessible and close to the module. The power switch should be marked with a label telling it will switch off the voltage to the module.

UL INSTALLATION REQUIREMENTS:

For use on a flat surface of a type 1 enclosure

Use 60/75°C copper conductors only

Enclosure rating (face only)..... NEMA type 4X, UL50E

Max. ambient temperature..... 60°C

Max. wire size, pins 41...46..... AWG 30-16

Max. wire size, others AWG 30-12

UL file number..... E248256

CALIBRATION AND ADJUSTMENT:

During calibration and adjustment, the measuring and connection of external voltages must be carried out according to the specifications of this manual. The technician must use tools and instruments that are safe to use.

NORMAL OPERATION:

Operators are only allowed to adjust and operate modules that are safely fixed in panels, etc., thus avoiding the danger of personal injury and damage. This means there is no electrical shock hazard, and the module is easily accessible.

CLEANING:

When disconnected, the module may be cleaned with a cloth moistened with distilled water.

LIABILITY:

To the extent the instructions in this manual are not strictly observed, the customer cannot advance a demand against PR electronics A/S that would otherwise exist according to the concluded sales agreement.

DECLARATION OF CONFORMITY

As manufacturer

PR electronics A/S

Lerbakken 10

DK-8410 Rønde

hereby declares that the following product:

Type: 5714

Name: Programmable LED indicator

is in conformity with the following directives and standards:

The EMC Directive 2004/108/EC and later amendments

EN 61326-1

For specification of the acceptable EMC performance level, refer to the electrical specifications for the module.

The Low Voltage Directive 2006/95/EC and later amendments

EN 61010-1

Rønde, 22 December 2009



Kim Rasmussen
Manufacturer's signature

FRONT AND BACK LAYOUT



Picture 1: Front of PReview 5714.

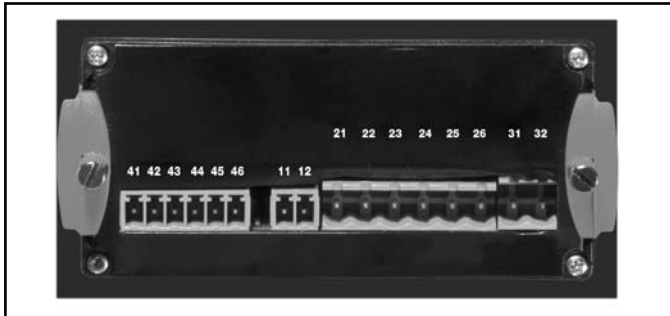

Picture 2: Back of PReview 5714.

PROGRAMMABLE LED INDICATOR PREVIEW 5714

- 4-digit 14-segment LED indicator
- Input for mA, V, potentiometer, RTD and TC
- 2 relays and analogue output
- Universal voltage supply
- Front key programmable

Application:

- Display for digital readout of current, voltage, temperature or potentiometer signals.
- Process control with 2 pairs of potential-free relays and / or analogue output.
- For local readout in extremely wet atmospheres with a specially designed splash-proof cover.

Technical characteristics:

- 4-digit LED indicator with 13.8 mm 14-segment characters. Max. display readout -1999...9999 with programmable decimal point, relay ON / OFF indication.
- All operational parameters can be adjusted to any application by use of the front keys.
- PReview 5714 is available fully-configured acc. to specifications ready for process control and visualisation.
- Help texts in eight languages can be selected via a menu item.
- In versions with relay outputs the user can minimise the installation test time by activating / deactivating each relay independently of the input signal.

Mounting:

- To be mounted in front panel. The included rubber packing must be mounted between the panel cutout hole and the display front to obtain a protection degree of IP65 (NEMA 4X). For extra protection in extreme environments, PReview 5714 can be delivered with a specially designed splash-proof cover as accessory.

Applications

Input signals:

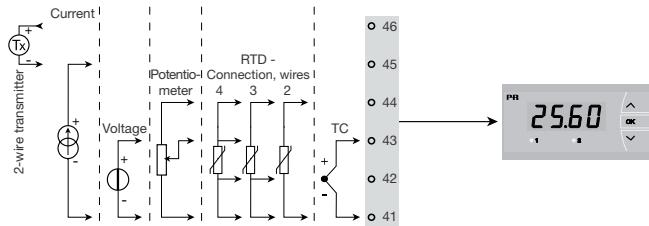

Output signals:

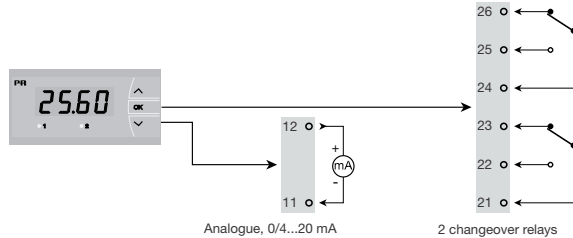

Supply:

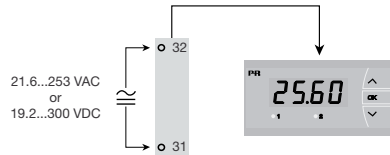

Order: 5714

Type	Version
5714	Standard. : A 2 relays. : B Analogue output. : C Analogue output and 2 relays . . . : D

NB! Please order the splash-proof cover separately. Order No. 8335.

Electrical specifications:

Specifications range:

-20°C to +60°C

Common specifications:

Supply voltage, universal 21.6...253 VAC, 50...60 Hz or
19.2...300 VDC

Consumption

Type	Internal consumption	Max. consumption
5714A	2.2 W	2.5 W
5714B	2.7 W	3.0 W
5714C	2.7 W	3.0 W
5714D	3.2 W	3.5 W

Isolation voltage, test / operation 2.3 kVAC / 250 VAC

Signal- / noise ratio Min. 60 dB (0...100 kHz)

Response time (0...90 %, 100...10 %), programmable:

Temperature input..... 1...60 s

Current / voltage input..... 0.4...60 s

Calibration temperature..... 20...28°C

Accuracy, the greater of general and basic values:

General values		
Input type	Absolute accuracy	Temperature coefficient
All	≤ ±0.1% of reading	≤ ±0.01% of reading / °C

Basic values		
Input type	Basic accuracy	Temperature coefficient
mA	≤ ±4 µA	≤ ±0.4 µA / °C
Volt	≤ ±20 µV	≤ ±2 µV / °C
Potentiometer	≤ ±0.1 Ω	≤ ±0.01 Ω / °C
Pt100	≤ ±0.2°C	≤ ±0.02°C / °C
Ni100	≤ ±0.3°C	≤ ±0.03°C / °C
TC type: E, J, K, L, N, T, U	≤ ±1°C	≤ ±0.05°C / °C
TC type: R, S, W3, W5, LR	≤ ±2°C	≤ ±0.2°C / °C
TC type: B 160...400°C	≤ ±4.5°C	≤ ±0.45°C / °C
TC type: B 400...1820°C	≤ ±2°C	≤ ±0.2°C / °C

EMC immunity influence < ±0,5% of reading

Auxiliary supplies:

2 wire supply (pin 46...45) 25...15 VDC / 0...20 mA
 Wire size, pin 41...46 (max.) 1 x 1.5 mm² stranded wire
 Wire size, others (max.) 1 x 2.5 mm² stranded wire
 Relative humidity < 95% RH (non cond.)
 Dimensions (HxWxD) 48 x 96 x 120 mm
 Cutout dimensions 44.5 x 91.5 mm
 Protection degree (mounted in panel) IP65 / NEMA type 4x, UL50E
 Weight 230 g

RTD and potentiometer input:

Input type	Min. value	Max. value	Standard
Pt100	-200°C	+850°C	IEC60751
Ni100	-60°C	+250°C	DIN 43760
Potentiometer	10 Ω	100 kΩ	-

Input for RTD types:

Pt10, Pt20, Pt50, Pt100, Pt200, Pt250, Pt300, Pt400, Pt500, Pt1000
 Ni50, Ni100, Ni120, Ni1000
 Cable resistance pr. wire, RTD (max.) 50 Ω

Sensor current, RTD Nom. 0.2 mA
 Effect of sensor cable resistance
 (3- / 4-wire), RTD < 0.002 Ω / Ω
 Sensor error detection, RTD Yes
 Short circuit detection, RTD < 15 Ω

TC input:

Type	Min. value	Max. value	Standard
B	0°C	+1820°C	IEC 60584-1
E	-100°C	+1000°C	IEC 60584-1
J	-100°C	+1200°C	IEC 60584-1
K	-180°C	+1372°C	IEC 60584-1
L	-200°C	+900°C	DIN 43710
N	-180°C	+1300°C	IEC 60584-1
R	-50°C	+1760°C	IEC 60584-1
S	-50°C	+1760°C	IEC 60584-1
T	-200°C	+400°C	IEC 60584-1
U	-200°C	+600°C	DIN 43710
W3	0°C	+2300°C	ASTM E988-90
W5	0°C	+2300°C	ASTM E988-90
LR	-200°C	+800°C	GOST 3044-84

Cold junction compensation (CJC)

via internal sensor ±(2.0°C + 0.4°C * Δt)

Δt = internal temperature - ambient temperature

Sensor error detection, all TC types Yes

Sensor error detection Yes

Sensor error current:

when detecting Nom. 2 µA

else 0 µA

Current input:

Measurement range 0...20 mA

Programmable measurement ranges 0...20 and 4...20 mA

Input resistance Nom. 20 Ω + PTC 25 Ω

Sensor error detection:

loop break 4...20 mA Yes

Voltage input:

Measurement range 0...12 VDC

Programmable measurement ranges 0...1 / 0,2...1 /

0...10 / 2...10 VDC

Input resistance Nom. 10 MΩ

Outputs:

Display:

Display readout	-1999...9999 (4 digits)
Decimal point	Programmable
Digit height	13.8 mm
Display updating	2.2 times / s
Input outside input range is indicated by.....	Explanatory text

Current output:

Signal range (span).....	0...20 mA
Programmable signal ranges	0...20 / 4...20 / 20...0 / 20...4 mA
Load (max.).....	20 mA / 800 Ω / 16 VDC
Load stability	≤ 0.01% of span / 100 Ω
Sensor error detection	0 / 3.5 / 23 mA / none
NAMUR NE 43 up / downscale	23 mA / 3.5 mA
Output limitation:	
on 4...20 and 20...4 mA signals.....	3.8...20.5 mA
on 0...20 and 20...0 mA signals.....	0...20.5 mA
Current limit.....	≤ 28 mA

Relay outputs:

Relay function.....	Setpoint
Hysteresis, in % / display counts	0.1...25% / 1...2999
On and Off delay	0...3600 s
Sensor error detection	Make / Break / Hold
Max. voltage.....	250 VRMS
Max. current	2 A / AC
Max. AC power	500 VA
Max. current at 24 VDC.....	1 A

Marine approval:

Det Norske Veritas, Ships & Offshore	Standard for Certification No. 2.4
--	------------------------------------

GOST R approval:

VNIIM, Cert. no.....	See www.prelectronics.com
----------------------	--

Observed authority requirements:

Standard:

EMC 2004/108/EC	EN 61326-1
LVD 2006/95/EC.....	EN 61010-1
UL, Standard for Safety	UL 508

Sensor error detection / sensor error detection outside range:

Sensor error check in 5714 variants		
Variant:	Configuration	Sensor error detection:
5714A	Always:	ON
	ERR1=NONE, ERR2=NONE:	OFF
5714B	else:	ON
	O.ERR=NONE:	OFF
5714C	else:	ON
	ERR1=NONE, ERR2=NONE, O.ERR=NONE:	OFF
5714D	else:	ON

Outside range readout (IN.LO, IN.HI): If the valid range of the A/D converter or the polynomial is exceeded			
Input	Range	Readout	Limit
VOLT	0..1 V / 0.2..1 V	IN.LO	< -25 mV
		IN.HI	> 1.2 V
	0..10 V / 2..10 V	IN.LO	< -25 mV
		IN.HI	> 12 V
CURR	0..20 mA / 4..20 mA	IN.LO	< -1.05 mA
		IN.HI	> 25.05 mA
POTM	-	IN.LO	< -0.5%
		IN.HI	> 100.5%
TEMP	TC / RTD	IN.LO	< temperature range
		IN.HI	> temperature range

Sensor error detection (SE.BR, SE.SH):			
Input	Range	Readout	Limit
CURR	Loop break (4..20mA)	SE.BR	<= 3.6 mA; > = 21 mA
		SE.SH	> ca. 750 kohm / (1,25V)
TEMP	TC	SE.BR	> ca. 15 kohm
		SE.SH	< ca. 15 ohm
	Pt100 2-wire No SE.SH for Pt10, Pt20 and Pt50	SE.BR	> ca. 15 kohm
		SE.SH	< ca. 15 ohm
	Pt100 3-wire No SE.SH for Pt10, Pt20 and Pt50	SE.BR	> ca. 15 kohm
		SE.SH	< ca. 15 ohm
Pt100 4-wire No SE.SH for Pt10, Pt20 and Pt50	SE.BR	> ca. 15 kohm	
	SE.SH	< ca. 15 ohm	

Display readout below min. / above max. (-1.9.9.9, 9.9.9.9):			
Input	Range	Readout	Limit
CURR	All	-1.9.9.9	Display readout <-1999
		9.9.9.9	Display readout >9999
VOLT	All	-1.9.9.9	Display readout <-1999
		9.9.9.9	Display readout >9999
POTM	-	-1.9.9.9	Display readout <-1999
		9.9.9.9	Display readout >9999

Readout at hardware error		
Error search	Readout	Error cause
Test of internal communication uC / ADC	HW.ER	Permanent error in ADC
Test of internal CJC sensor	CJ.ER	CJC sensor defect
Check-sum test of the configuration in RAM	RA.ER	Error in RAM
Check-sum test of the configuration in EEPROM	EE.ER	Error in EEPROM

! Error indications in the display blink once a second. The help text explains the error.

CONNECTIONS

Inputs:

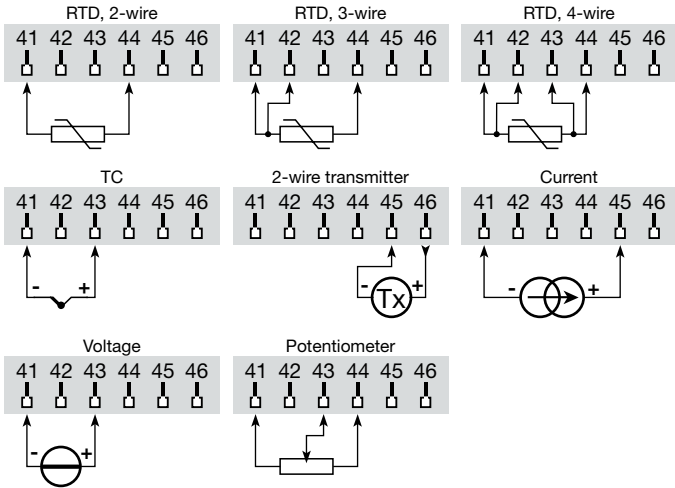

Supply:

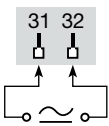

Current

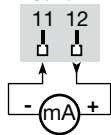

Output:

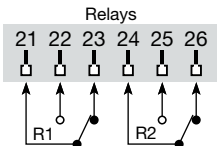

BLOCK DIAGRAM

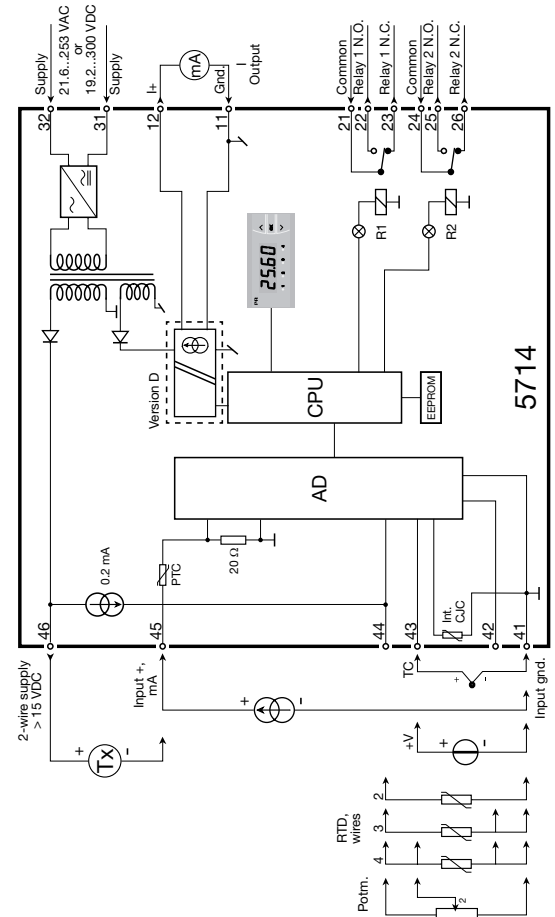

SCROLLING HELP TEXT

Display in default state xxxx, hardware error:

SE.BR --> SENSOR WIRE BREAKAGE
SE.SH --> SENSOR SHORT CIRCUIT
IN.HI --> INPUT OVERRANGE
IN.LO --> INPUT UNDERRANGE
9.9.9.9 --> DISPLAY OVERRANGE
-1.9.9.9 --> DISPLAY UNDERRANGE
HW.ER --> HARDWARE ERROR
EE.ER --> EEPROM ERROR - CHECK CONFIGURATION
RA.ER --> RAM MEMORY ERROR
CJ.ER --> CJC SENSOR ERROR

Fastset (Enabled):

F.SET
REL1 --> FAST SET MENU - SELECT RELAY

REL2 -->

SETP
 xxxxx --> RELAY SETPOINT - PRESS OK TO SAVE

Fastset (Disabled):

SETP
 xxxxx --> RELAY SETPOINT - READ ONLY

Configuration menus:

LANG
DE --> DE - WAEHLE DEUTSCHEN HILFETEXT
DK --> DK - VAELG DANSK HJALPETEKST
ES --> ES - SELECCIONAR TEXTO DE AYUDA EN ESPANOL
FR --> FR - SELECTION TEXTE D'AIDE EN FRANCAIS
IT --> IT - SELEZIONARE TESTI DI AIUTO ITALIANI
SE --> SE - VALJ SVENSK HJALPTEXT
UK --> UK - SELECT ENGLISH HELPTEXT
CZ --> CZ - VYBER CESKOU NAPOVEDU

PASS
 xxxxx --> SET CORRECT PASSWORD

IN
C.LIN* --> TEXT ENTERED BY USER IN PRESET
CURR --> CURRENT INPUT
VOLT --> VOLTAGE INPUT
POTM --> POTENTIOMETER INPUT
TEMP --> TEMPERATURE SENSOR INPUT

RANG **When current selected:**
 0-20 --> INPUT RANGE IN mA
 4-20 --> INPUT RANGE IN mA

RANG **When voltage selected:**
 0-10 --> INPUT RANGE IN VOLT
 2-10 --> INPUT RANGE IN VOLT
 0.0-1 --> INPUT RANGE IN VOLT
 0.2-1 --> INPUT RANGE IN VOLT

CA.LO
YES --> CALIBRATE POTENTIOMETER LOW
NO --> CALIBRATE POTENTIOMETER LOW

CA.HI
YES --> CALIBRATE POTENTIOMETER HIGH
NO --> CALIBRATE POTENTIOMETER HIGH

DEC.P
 1111 --> DECIMAL POINT POSITION
 111.1 --> DECIMAL POINT POSITION
 11.11 --> DECIMAL POINT POSITION
 1.111 --> DECIMAL POINT POSITION

DI.LO
 xxxxx --> DISPLAY READOUT LOW

DI.HI
 xxxxx --> DISPLAY READOUT HIGH

REL.U
PERC --> SET RELAY IN PERCENTAGE
DISP --> SET RELAY IN DISPLAY UNITS

TYPE
PT --> SELECT PT SENSOR TYPE
NI --> SELECT NI SENSOR TYPE
TC --> SELECT TC SENSOR TYPE

PT.TY
 10 --> SELECT PT SENSOR TYPE
 20 --> SELECT PT SENSOR TYPE
 50 --> SELECT PT SENSOR TYPE
 100 --> SELECT PT SENSOR TYPE
 200 --> SELECT PT SENSOR TYPE
 250 --> SELECT PT SENSOR TYPE
 300 --> SELECT PT SENSOR TYPE
 400 --> SELECT PT SENSOR TYPE
 500 --> SELECT PT SENSOR TYPE
 1000 --> SELECT PT SENSOR TYPE

NI.TY
 50 --> SELECT NI SENSOR TYPE
 100 --> SELECT NI SENSOR TYPE
 120 --> SELECT NI SENSOR TYPE
 1000 --> SELECT NI SENSOR TYPE

CONN **When Pt and Ni sensor selected**
2W --> SELECT 2-WIRE SENSOR CONNECTION
3W --> SELECT 3-WIRE SENSOR CONNECTION
4W --> SELECT 4-WIRE SENSOR CONNECTION

TC.TY
TC.B --> SELECT TC SENSOR TYPE
TC.E --> SELECT TC SENSOR TYPE
TC.J --> SELECT TC SENSOR TYPE
TC.K --> SELECT TC SENSOR TYPE
TC.L --> SELECT TC SENSOR TYPE
TC.N --> SELECT TC SENSOR TYPE
TC.F --> SELECT TC SENSOR TYPE
TC.S --> SELECT TC SENSOR TYPE
TC.T --> SELECT TC SENSOR TYPE
TC.U --> SELECT TC SENSOR TYPE
TC.W3 --> SELECT TC SENSOR TYPE
TC.W5 --> SELECT TC SENSOR TYPE
TC.LR --> SELECT TC SENSOR TYPE

DEC.P **When temperature selected**
 1111 --> DECIMAL POINT POSITION
 111.1 --> DECIMAL POINT POSITION

UNIT
°C --> DISPLAY AND RELAY SETUP IN CELSIUS
°F --> DISPLAY AND RELAY SETUP IN FAHRENHEIT

REL1
SET --> ENTER RELAY 1 SETUP
SKIP --> SKIP RELAY 1 SETUP
OFF --> RELAY 1 DISABLED

SETP
 xxxxx --> RELAY SETPOINT

ACT1
INCR --> ACTIVATE AT INCREASING SIGNAL
DECR --> ACTIVATE AT DECREASING SIGNAL

HYS1
 xxxxx --> RELAY HYSTERESIS

ERR1
HOLD --> HOLD RELAY AT ERROR
ACTI --> ACTIVATE RELAY AT ERROR
DEAC --> DEACTIVATE RELAY AT ERROR
NONE --> UNDEFINED STATUS AT ERROR

ON.DE
 xxxxx --> RELAY ON-DELAY IN SECONDS

OF.DE
 xxxxx --> RELAY OFF-DELAY IN SECONDS

REL2
SET --> ENTER RELAY 2 SETUP
SKIP --> SKIP RELAY 2 SETUP
OFF --> RELAY 2 DISABLED

SETP
 xxxxx --> RELAY SETPOINT

ACT2
INCR --> ACTIVATE AT INCREASING SIGNAL
DECR --> ACTIVATE AT DECREASING SIGNAL

HYS2
 xxxxx --> RELAY HYSTERESIS

ERR2
HOLD --> HOLD RELAY AT ERROR
ACTI --> ACTIVATE RELAY AT ERROR
DEAC --> DEACTIVATE RELAY AT ERROR
NONE --> UNDEFINED STATUS AT ERROR

ON.DE
 xxxxx --> RELAY ON-DELAY IN SECONDS

OF.DE
 xxxxx --> RELAY OFF-DELAY IN SECONDS

A.OUT
 0-20 --> OUTPUT RANGE IN mA
 4-20 --> OUTPUT RANGE IN mA
 20-0 --> OUTPUT RANGE IN mA
 20-4 --> OUTPUT RANGE IN mA

O.LO
 xxxxx --> DISPLAY VALUE FOR OUTPUT LOW

O.HI
 xxxxx --> DISPLAY VALUE FOR OUTPUT HIGH

O.ERR
 23 mA --> NAMUR NE43 UPSCALE AT ERROR
 3,5 mA --> NAMUR NE43 DOWNSCALE AT ERROR
 0mA --> DOWNSCALE AT ERROR
 NONE --> UNDEFINED OUTPUT AT ERROR

RESP
 xxx,x --> ANALOGUE OUTPUT RESPONSE TIME IN SECONDS

E.PAS
NO --> ENABLE PASSWORD PROTECTION
YES --> ENABLE PASSWORD PROTECTION

N.PAS
 xxxxx --> SELECT NEW PASSWORD

CONFIGURATION / OPERATING THE FUNCTION KEYS

Documentation for routing diagram.

In general:

When configuring the display you are guided through all parameters, you can choose the settings which fit the application. For each menu there is a scrolling help text which is automatically shown in the display, this starts after 5 seconds if no key has been activated.

Configuration is carried out by using the 3 function keys.

- ⬆ will increase the numerical value or choose the next parameter.
- ⬇ will decrease the numerical value or choose the previous parameter.
- Ⓚ will accept the chosen value and end the menu.

If a function does not exist in the display all parameters are skipped to make the configuration as simple as possible.

Once the configuration has been entered the display will show “----”.

Pressing and holding Ⓚ will return to the previous menu or return to the default state (1.0) without saving the changed values or parameters.

If no key is activated for 2 minutes, the display will return to the default state (1.0) without saving the changed values or parameters.

Further explanations:

Fast setpoint adjustment and relay test: These menus allow you to change the set point quickly and to check the operation of the relays.

Pressing ⬆ and ⬇ at the same time will change the state of the relay – this change is indicated by the diodes on the display. Pressing Ⓚ will save the set point change.

Holding down Ⓚ for more than 0.5 seconds will return the unit to the default state without changing the set point.

Password protection:

Using a password will stop access to the menu and parameters. There are two levels of password protection. Passwords between 0000...4999 allow access to the fast set point adjustment and relay test. (Using this password stops access to all other parts of the menu). Passwords between 5000...9999 stop access to all parts of the menu, fast set point and relay test. (Current set point is still shown). By using the master password 2008, all configuration menus are available.

Graphic depiction of the relay function setpoint:

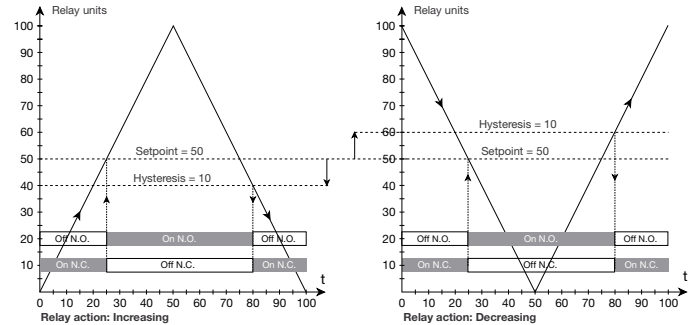

Distributed by:

Eurotron Instruments Benelux B.V.

Lage Traan 4f

9351 vL Leek, The Netherlands

Tel. (+31) 594 696 131

Fax (+31) 594 820 224

E-mail info@eurotronbenelux.nl

www.eurotronbenelux.nl