



Thermographic Handheld Camera

User Manual

Legal Information

©2020 Hangzhou Hikvision Digital Technology Co., Ltd. All rights reserved.

About this Manual

The Manual includes instructions for using and managing the Product. Pictures, charts, images and all other information hereinafter are for description and explanation only. The information contained in the Manual is subject to change, without notice, due to firmware updates or other reasons. Please find the latest version of this Manual at the Hikvision website (<https://www.hikvision.com/>).

Please use this Manual with the guidance and assistance of professionals trained in supporting the Product.

Trademarks

HIKVISION and other Hikvision's trademarks and logos are the properties of Hikvision in various jurisdictions.

Other trademarks and logos mentioned are the properties of their respective owners.

Disclaimer

TO THE MAXIMUM EXTENT PERMITTED BY APPLICABLE LAW, THIS MANUAL AND THE PRODUCT DESCRIBED, WITH ITS HARDWARE, SOFTWARE AND FIRMWARE, ARE PROVIDED "AS IS" AND "WITH ALL FAULTS AND ERRORS". HIKVISION MAKES NO WARRANTIES, EXPRESS OR IMPLIED, INCLUDING WITHOUT LIMITATION, MERCHANTABILITY, SATISFACTORY QUALITY, OR FITNESS FOR A PARTICULAR PURPOSE. THE USE OF THE PRODUCT BY YOU IS AT YOUR OWN RISK. IN NO EVENT WILL HIKVISION BE LIABLE TO YOU FOR ANY SPECIAL, CONSEQUENTIAL, INCIDENTAL, OR INDIRECT DAMAGES, INCLUDING, AMONG OTHERS, DAMAGES FOR LOSS OF BUSINESS PROFITS, BUSINESS INTERRUPTION, OR LOSS OF DATA, CORRUPTION OF SYSTEMS, OR LOSS OF DOCUMENTATION, WHETHER BASED ON BREACH OF CONTRACT, TORT (INCLUDING NEGLIGENCE), PRODUCT LIABILITY, OR OTHERWISE, IN CONNECTION WITH THE USE OF THE PRODUCT, EVEN IF HIKVISION HAS BEEN ADVISED OF THE POSSIBILITY OF SUCH DAMAGES OR LOSS.

YOU ACKNOWLEDGE THAT THE NATURE OF INTERNET PROVIDES FOR INHERENT SECURITY RISKS, AND HIKVISION SHALL NOT TAKE ANY RESPONSIBILITIES FOR ABNORMAL OPERATION, PRIVACY LEAKAGE OR OTHER DAMAGES RESULTING FROM CYBER-ATTACK, HACKER ATTACK, VIRUS INSPECTION, OR OTHER INTERNET SECURITY RISKS; HOWEVER, HIKVISION WILL PROVIDE TIMELY TECHNICAL SUPPORT IF REQUIRED.

YOU AGREE TO USE THIS PRODUCT IN COMPLIANCE WITH ALL APPLICABLE LAWS, AND YOU ARE SOLELY RESPONSIBLE FOR ENSURING THAT YOUR USE CONFORMS TO THE APPLICABLE LAW. ESPECIALLY, YOU ARE RESPONSIBLE, FOR USING THIS PRODUCT IN A MANNER THAT DOES NOT INFRINGE ON THE RIGHTS OF THIRD PARTIES, INCLUDING WITHOUT LIMITATION, RIGHTS OF PUBLICITY, INTELLECTUAL PROPERTY RIGHTS, OR DATA PROTECTION AND OTHER PRIVACY RIGHTS. YOU SHALL NOT USE THIS PRODUCT FOR ANY PROHIBITED END-USES, INCLUDING THE DEVELOPMENT OR PRODUCTION OF WEAPONS OF MASS DESTRUCTION, THE DEVELOPMENT OR

Thermographic Handheld Camera User Manual

PRODUCTION OF CHEMICAL OR BIOLOGICAL WEAPONS, ANY ACTIVITIES IN THE CONTEXT RELATED TO ANY NUCLEAR EXPLOSIVE OR UNSAFE NUCLEAR FUEL-CYCLE, OR IN SUPPORT OF HUMAN RIGHTS ABUSES.

IN THE EVENT OF ANY CONFLICTS BETWEEN THIS MANUAL AND THE APPLICABLE LAW, THE LATER PREVAILS.

Regulatory Information

FCC Information

Please take attention that changes or modification not expressly approved by the party responsible for compliance could void the user's authority to operate the equipment.

FCC compliance: This equipment has been tested and found to comply with the limits for a Class B digital device, pursuant to part 15 of the FCC Rules. These limits are designed to provide reasonable protection against harmful interference in a residential installation. This equipment generates, uses and can radiate radio frequency energy and, if not installed and used in accordance with the instructions, may cause harmful interference to radio communications. However, there is no guarantee that interference will not occur in a particular installation. If this equipment does cause harmful interference to radio or television reception, which can be determined by turning the equipment off and on, the user is encouraged to try to correct the interference by one or more of the following measures:

- Reorient or relocate the receiving antenna.
- Increase the separation between the equipment and receiver.
- Connect the equipment into an outlet on a circuit different from that to which the receiver is connected.
- Consult the dealer or an experienced radio/TV technician for help

This equipment should be installed and operated with a minimum distance 20cm between the radiator and your body.

FCC Conditions

This device complies with part 15 of the FCC Rules. Operation is subject to the following two conditions:

1. This device may not cause harmful interference.
2. This device must accept any interference received, including interference that may cause undesired operation.

EU Conformity Statement



This product and - if applicable - the supplied accessories too are marked with "CE" and comply therefore with the applicable harmonized European standards listed under the EMC Directive 2014/30/EU, RE Directive 2014/53/EU, the RoHS Directive 2011/65/EU



2012/19/EU (WEEE directive): Products marked with this symbol cannot be disposed of as unsorted municipal waste in the European Union. For proper recycling, return this product to your local supplier upon the purchase of equivalent new equipment, or dispose of it at designated collection points. For more information see: www.recyclethis.info



2006/66/EC (battery directive): This product contains a battery that cannot be disposed of as unsorted municipal waste in the European Union. See the product documentation for specific battery information. The battery is marked with this symbol, which may include lettering to indicate cadmium (Cd), lead (Pb), or mercury (Hg). For proper recycling, return the battery to your supplier or to a designated collection point. For more information see: www.recyclethis.info

Industry Canada ICES-003 Compliance

This device meets the CAN ICES-3 (B)/NMB-3(B) standards requirements.

1. This device complies with Industry Canada licence-exempt RSS standard(s). Operation is subject to the following two conditions: this device may not cause interference, and
 2. this device must accept any interference, including interference that may cause undesired operation of the device.
-
1. Le présent appareil est conforme aux CNR d'Industrie Canada applicables aux appareils radioexempts de licence. L'exploitation est autorisée aux deux conditions suivantes : l'appareil ne doit pas produire de brouillage, et
 2. l'utilisateur de l'appareil doit accepter tout brouillage radioélectrique subi, même si le brouillage est susceptible d'en compromettre le fonctionnement.

Under Industry Canada regulations, this radio transmitter may only operate using an antenna of a type and maximum (or lesser) gain approved for the transmitter by Industry Canada. To reduce potential radio interference to other users, the antenna type and its gain should be so chosen that the equivalent isotropically radiated power (e.i.r.p.) is not more than that necessary for successful communication.



Conformément à la réglementation d'Industrie Canada, le présent émetteur radio peut fonctionner avec une antenne d'un type et d'un gain maximal (ou inférieur) approuvé pour l'émetteur par Industrie Canada. Dans le but de réduire les risques de brouillage radioélectrique à l'intention des autres utilisateurs, il faut choisir le type d'antenne et son gain de sorte que la puissance isotrope rayonnée équivalente (p.i.r.e.) ne dépasse pas l'intensité nécessaire à l'établissement d'une communication satisfaisante.

This equipment should be installed and operated with a minimum distance 20cm between the radiator and your body.

Cet équipement doit être installé et utilisé à une distance minimale de 20 cm entre le radiateur et votre corps.

Symbol Conventions

The symbols that may be found in this document are defined as follows.

Symbol	Description
 Danger	Indicates a hazardous situation which, if not avoided, will or could result in death or serious injury.
 Caution	Indicates a potentially hazardous situation which, if not avoided, could result in equipment damage, data loss, performance degradation, or unexpected results.
 Note	Provides additional information to emphasize or supplement important points of the main text.

Safety Instruction

These instructions are intended to ensure that user can use the product correctly to avoid danger or property loss.

Laws and Regulations

- Use of the product must be in strict compliance with the local electrical safety regulations.

Transportation

- Keep the device in original or similar packaging while transporting it.
- Keep all wrappers after unpacking them for future use. In case of any failure occurred, you need to return the device to the factory with the original wrapper. Transportation without the original wrapper may result in damage on the device and the company shall not take any responsibilities.
- Do not drop the product or subject it to physical shock. Keep the device away from magnetic interference.

Power Supply

- Please purchase the charger by yourself. Input voltage should meet the Limited Power Source (5 VDC, 2A) according to the IEC61010-1 standard. Please refer to technical specifications for detailed information.
- Make sure the plug is properly connected to the power socket.
- DO NOT connect multiple devices to one power adapter, to avoid over-heating or fire hazards caused by overload.

Battery

- Improper use or replacement of the battery may result in explosion hazard. Replace with the same or equivalent type only. Dispose of used batteries in conformance with the instructions provided by the battery manufacturer.
- The built-in battery cannot be dismantled. Please contact the manufacture for repair if necessary.
- For long-term storage of the battery, make sure it is fully charged every half year to ensure the battery quality. Otherwise, damage may occur.

Maintenance

- If the product does not work properly, please contact your dealer or the nearest service center. We shall not assume any responsibility for problems caused by unauthorized repair or maintenance.
- A few device components (e.g., electrolytic capacitor) require regular replacement. The average lifespan varies, so periodic checking is recommended. Contact your dealer for details.
- Wipe the device gently with a clean cloth and a small quantity of ethanol, if necessary.
- If the equipment is used in a manner not specified by the manufacturer, the protection provided by the device may be impaired.

Using Environment

- Make sure the running environment meets the requirement of the device. The operating temperature shall be -10°C to 50°C (14°F to 122°F), and the operating humidity shall be 90% or less.
- DO NOT expose the device to high electromagnetic radiation or dusty environments.
- DO NOT aim the lens at the sun or any other bright light.

Emergency

- If smoke, odor, or noise arises from the device, immediately turn off the power, unplug the power cable, and contact the service center.

Laser Light Supplement Warning

The laser radiation emitted from the device can cause eye injuries, burning of skin or inflammable substances. Before enabling the Light Supplement function, make sure no human or inflammable substances are in front of the laser lens.

Manufacture Address

No.555 Qianmo Road, Binjiang District, Hangzhou 310052, China
Hangzhou Hikvision Digital Technology Co.,Ltd

User Manual of Electrical Version

Scan the QR code to view the user manual on your mobile phone. Note that mobile data charges may apply if Wi-Fi is unavailable.



Contents

Chapter 1 Overview.....	1
1.1 Device Description.....	1
1.2 Main Function.....	1
1.3 Appearance.....	2
Chapter 2 Preparation	4
2.1 Charge Device	4
2.1.1 Charge Device via Charging Base	4
2.1.2 Charge Device via Cable Interface	5
2.2 Power On/Off	5
2.2.1 Set Auto Power-off Duration	6
2.3 Operation Method	6
2.4 Menu Description	6
Chapter 3 Display Settings	8
3.1 Focus Lens	8
3.2 Set Screen Brightness	8
3.3 Set Display Mode.....	8
3.4 Set Palettes	9
3.5 Adjust Digital Zoom	10
3.6 Display OSD Info	11
Chapter 4 Temperature Measurement.....	12
4.1 Set Thermography Parameters	12
4.1.1 Set Unit	13
4.2 Set Temperature Range	13
4.3 Set Thermography Rule.....	13
4.3.1 Set Point Rule	14
4.3.2 Set Line Rule	15
4.3.3 Set Frame Rule.....	15
4.3.4 Delete Rules.....	16
4.4 Set Temperature Alarm.....	16

Chapter 5 Picture and Video	17
5.1 Capture Picture	17
5.2 Record Video	18
5.3 View Recorded Files	19
5.4 Export Files	19
Chapter 6 Connect Bluetooth	21
Chapter 7 Light Settings.....	22
7.1 Set LED Light	22
7.2 Set Laser.....	22
Chapter 8 Hik-Thermal APP Connection	23
8.1 Connect via Wi-Fi.....	23
8.2 Connect via Hot Spot.....	24
Chapter 9 Maintenance	26
9.1 View Device Information	26
9.2 Set Date and Time	26
9.3 Upgrade Device	26
9.4 Restore Device.....	26
Chapter 10 Appendix.....	27
10.1 Common Material Emissivity Reference	27
10.2 Device Command.....	27
10.3 Device Communication Matrix	28

Chapter 1 Overview

1.1 Device Description

The thermographic handheld camera is a device with both optical images and thermal images. It can do thermography, video recording, snapshot capturing, alarm, and it can connect to Wi-Fi, hotspot and Bluetooth. The built-in high-sensitivity IR detector and high-performance sensor detects the variation of temperature and measure the real-time temperature.

The picture-in-picture technique of the camera and the fusion of optical view and thermal view, enhances the details of the images display. It supports multiple palettes and alarm types. When the detected temperature in the scene does not match with the alarm rules, the device alarms by color of the palette mode automatically. It helps to find the risky part and lower your property loss.

The device is easy to use, and adopts ergonomic design. It is widely applied to substations, electricity prevention detection of companies, and reconnaissance survey of construction field.

1.2 Main Function

Thermography

Device detects the real-time temperature, and display it on the screen.

Storage

Device is equipped with memory module to store videos, snapshots, and important data.

Fusion

Device can display fusion of thermal view and optical view.

Palette and Alarm

Device supports multiple palettes, and you can set the palette mode according to the alarm function.

Client Software Connection

You can connect the device with client software via Wi-Fi or hot spot. Then you can view live view, capture, and recording, etc. on your phone.

Bluetooth

Device can be connected to headset via Bluetooth, and you can hear the voice in the recording or capture.

Digital Zoom

Device supports 1x, 2x, 4x, and 8x digital zoom.

LED Light

LED light supplement makes the device a torch in required scenarios.

Laser Light

Long-distance laser light supplement.

1.3 Appearance

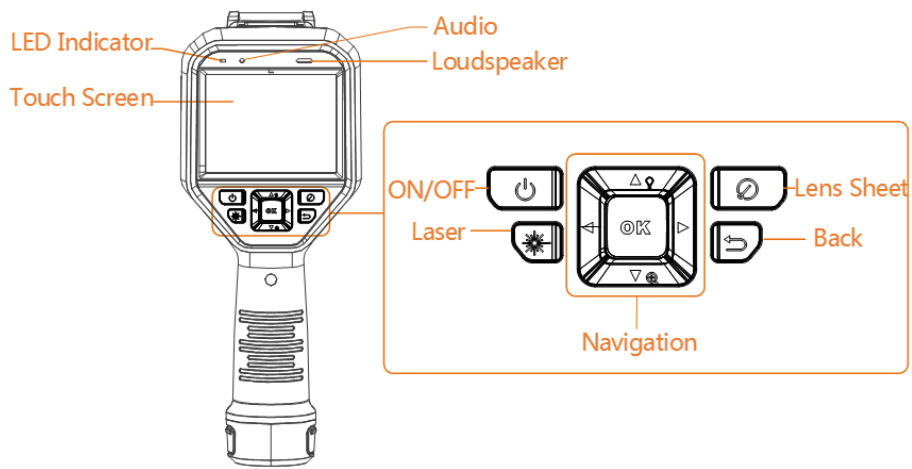

Figure 1-1 Appearance

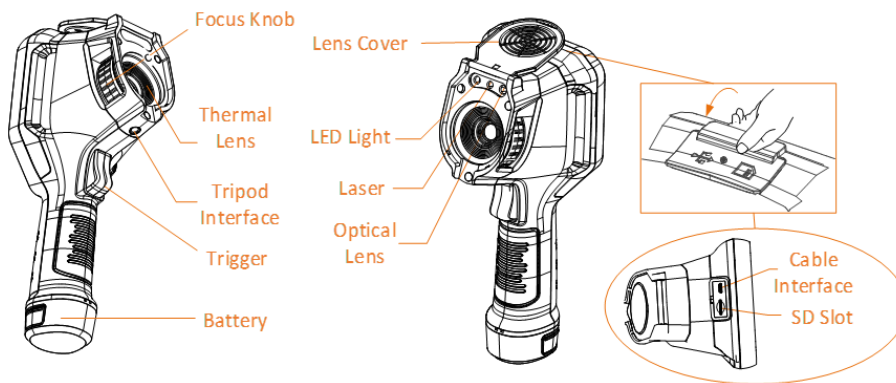

Table 1-1 Interface Description

Component	Function
Laser Button	Hold the button to turn on laser, and release the button to turn off laser.
Navigation Button	Menu Mode: <ul style="list-style-type: none"> ● Press Δ, ∇, \triangleright and \triangleleft to select parameters. ● Press OK to confirm.

Component	Function
	Non-Menu Mode: <ul style="list-style-type: none">● Press Δ to turn on/off the LED light supplement.● Press ∇ to start digital zoom.
Lens Sheet Button	Cover the lens to perform the correction.
Back Button	Exit the menu or return to previous menu.
Focus Knob	Adjust lens focal length. Refer to <i>Focus Lens</i> .
Trigger	Pull the trigger to capture. Hold the trigger to record videos.
Cable Interface	Connect the device to your PC via cable to export files.

Caution

The laser radiation emitted from the device can cause eye injuries, burning of skin or inflammable substances. Before enabling the light supplement function, make sure no human or inflammable substances are in front of the laser lens.

Chapter 2 Preparation

2.1 Charge Device

2.1.1 Charge Device via Charging Base

Steps

 **Note**

Please charge the device with the cable and power adapter supplied by the manufacturer (or according to the input voltage from the specifications).

1. Hold the device, and press both battery lock catches of the device.

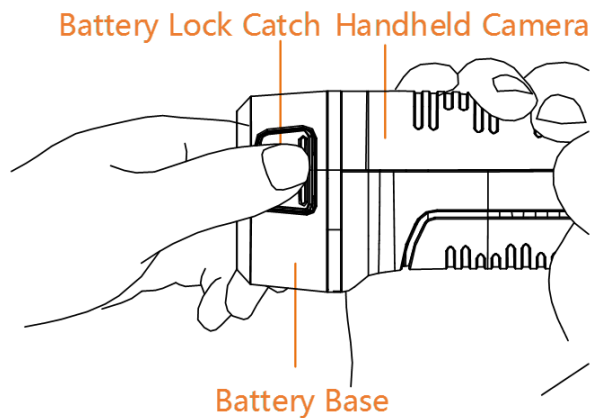

Figure 2-1 Remove Battery Base

2. Hold the lock catches, and draw the battery base to take out the battery.
3. Insert the battery into the charging base. You can see the charging status via the pilot lamp on the charging base.

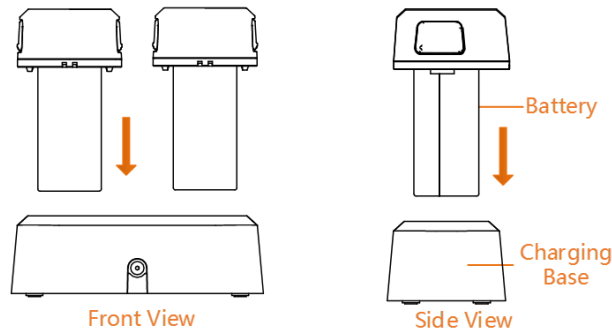

Figure 2-2 Charge Battery

4. When the battery is fully charged, draw the battery from the charging base.
5. Align the ribbed piece on battery with the notch of the device, and insert battery into the device.

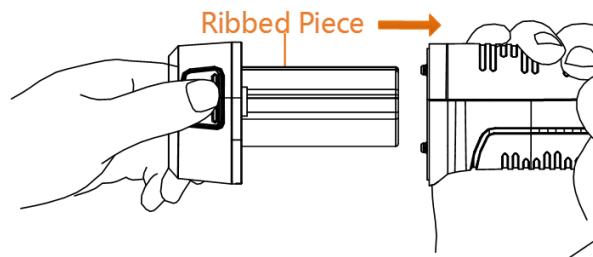

Figure 2-3 Insert Battery

2.1.2 Charge Device via Cable Interface

Before You Start

Please make sure the battery is installed before charging.

Steps

1. Open the top cover of the device.
2. Connect the interface and the power adaptor with Type-C or USB cable.

2.2 Power On/Off

Power On

Remove the lens cover, and hold  for over three seconds to turn on the device. You can observe the target when the interface of the device is stable.

Note

It may take at least 30 s until the device is ready for using when you power on it.

Power Off

When the device is turned on, hold  for three seconds to power off the device.

2.2.1 Set Auto Power-off Duration

Go to **Local Settings** → **Device Settings** → **Auto Power-off Duration Settings** to set the automatic shutdown time for device as required.

2.3 Operation Method

The device supports both touch-screen control and button control.

Touch-screen control

Tap on the screen to set parameters and configurations.







Figure 2-4 Touch-screen Control

Button control

Press the navigation buttons to set parameters and configurations.



Figure 2-5 Button Control

- Press , , , and  to move the cursor up/down/left/right.
- Press  to confirm.

2.4 Menu Description

In the observation interface, tap the screen or press  to show the menu bar.

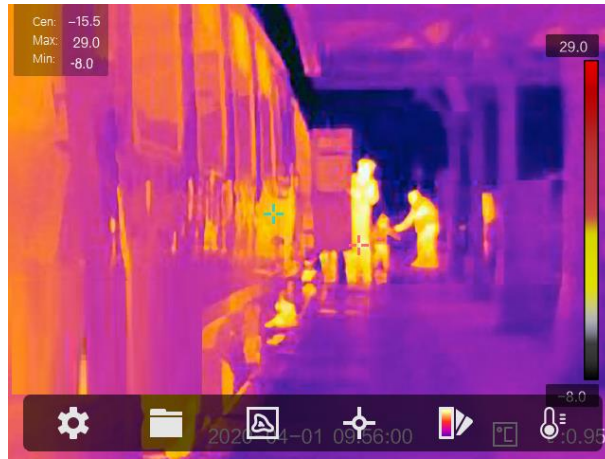

Figure 2-6 Menu

Chapter 3 Display Settings

3.1 Focus Lens

Adjust the lens focal length properly before you set any other configurations, or it may affect the image display and temperature accuracy.

Steps

1. Power on the device.
2. Aim the device lens to the appropriate scene.
3. Adjust the focus knob clockwise or anticlockwise, see figure below.

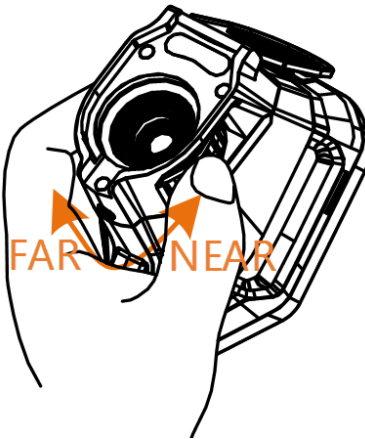

Figure 3-1 Focus Lens

Note

DO NOT touch the lens to avoid affecting the display effect.

3.2 Set Screen Brightness

Go to **Local Settings** → **Device Settings** → **Display Brightness** to set the screen brightness. It can be set as **Low**, **Medium**, or **High**.

3.3 Set Display Mode

You can set the thermal/optical view of the device. **Thermal**, **Fusion**, **PIP**, and **Optical** are selectable.

Steps

1. Select  from the main menu.

2. Tap on the icons to select a view mode.



In thermal mode, the device displays the thermal view.



In fusion mode, the device displays the combined view of thermal channel and optical channel.

Note

You can press and to set the fusion distance. Or go to **Local Settings** → **Image Settings** → **Parallax Correction** to select the fusion distance.



In PiP (Picture in Picture) mode, the device displays thermal view inside the optical view.

Note

You can press and to set the PiP proportion. Or go to **Local Settings** → **Image Settings** → **PiP Proportion** to set the value.



In optical mode, the device displays the optical view.

3. Press to exit.

3.4 Set Palettes

The palettes allow you to select the desired colors.

Steps

1. Select from the main menu.

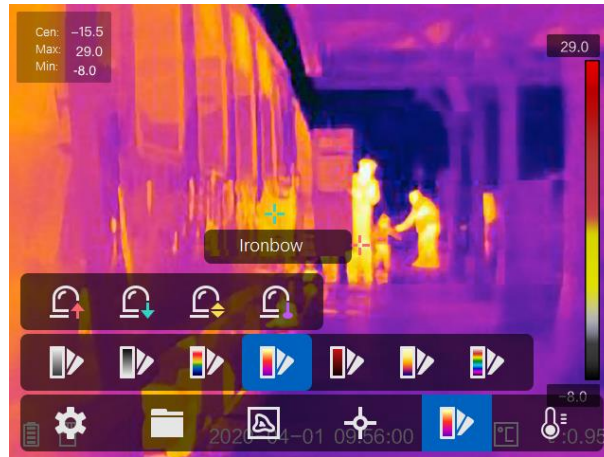

Figure 3-2 Palette

2. Tap on the icons to select a palette type.

White Hot

The hot part is light-colored in view.

Black Hot

The hot part is black-colored in view.

Rainbow

The target displays multiple colors, it is suitable for scene without obvious temperature difference.

Ironbow

The target is colored as heated iron.

Red Hot

The hot part is red-colored in view.

Fusion

The hot part is yellow-colored and the cold part is purple-colored in view.

Rain

The hot part in the image are colored, and the else is blue.

3. Press  to exit the setting interface.

3.5 Adjust Digital Zoom

In the live view interface, press  to adjust the digital zoom to 1×, 2×, 4×, or 8×. Then you can view the target or scene in larger size.

3.6 Display OSD Info

Go to **Local Settings** → **Image Settings** → **Display Settings** to enable the corresponding icons. Then you can view the device status, time, and target emissivity in live view interface.

Chapter 4 Temperature Measurement

The thermography (temperature measurement) function provides the real-time temperature of the scene and display it on the left of your screen. The thermography function is turned on by default.

4.1 Set Thermography Parameters

You can set thermography parameters to improve the accuracy of temperature measurement.

Steps

1. Go to **Local Settings** → **Thermography Settings**.
2. Set the **Thermography Range**, and **Emissivity**, etc.

Thermography Range

Select the temperature measurement range. The device can detect the temperature and switch thermography range automatically in **Auto Switch** mode.

Emissivity

Refer to **Common Material Emissivity Reference** to set the emissivity of your target.

Reflection Temperature

If any object (not the target) of high temperature is in the scene, and the target emissivity is low, set the reflection temperature as the high temperature to correct the thermography effect.

Distance

The distance between the target and the device. You can customize the target distance or select the target distance as **Near**, **Middle**, or **Far**.

Environment Temperature

The average temperature of the environment.

Humidity

Set the relative humidity of current environment.

Note

Go to **Local Settings** → **Image Settings** → **Display Settings** to enable/disable the emissivity display.

3. Return to previous menu to save the settings.

Note

You can go to **Local Settings** → **Device Settings** → **Device Initialization** → **Measurement Tool Initialization** to initialize the temperature measurement parameters.

4.1.1 Set Unit

Go to **Local Settings** → **Device Settings** → **Unit** to set the temperature unit and distance unit.

Note

You can go to **Local Settings** → **Image Settings** → **Display Settings** to enable/disable the temperature display.



4.2 Set Temperature Range

Set a temperature section and the palette only works for targets within the temperature section. You can adjust the temperature range.

Steps





1. Select  from the main menu.
2. Select auto adjustment  or manual adjustment .

Auto Adjustment

Select , and press . The device adjusts temperature range parameters automatically.

Manual Adjustment

Select , and press .

- Press  or  to select the max. temperature, min. temperature, or both. You can also tap on the screen to select the max. temperature or min. temperature.
- Press  or  adjust the temperature value. You can also tap on the arrows on the right side of the screen to adjust the temperature value.

3. Press  to exit.

4.3 Set Thermography Rule

You can set thermography parameters to improve the accuracy of temperature measurement.

Steps

1. Select  from the main menu.

2. Set the point, line, or frame rules. See figure below.

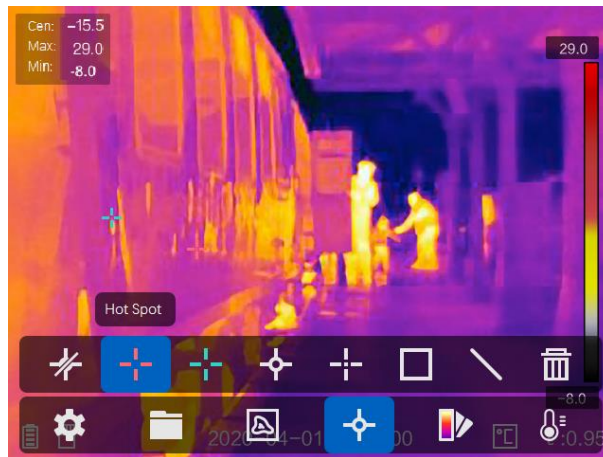

Figure 4-1 Set Thermography Rule

4.3.1 Set Point Rule

You can set four types of point thermography rules.

Table 4-1 Icon Description

Icon	Description
	Center Point Thermography
	High-temperature Point Thermography
	Low-temperature Point Thermography
	Custom Point Thermography

The setting method of center point, high-temperature, and low-temperature point thermography are all the same. Here is the example of setting high-temperature point thermography.

Example

Tap on the interface, the device locates the point of the highest temperature, and displays Max: XX.

Custom Point Thermography

The device can detect the temperature of a custom point.

Steps

1. Select
2. Press
3. Move the point with the navigation buttons or tap on the touch-screen to select a point.
4. Press

The temperature of custom point (e.g. P1) displays P1: XX.







5. Repeat step 1 to 3 to set other custom points.
-

Note

At most ten custom points supported.

4.3.2 Set Line Rule

Steps

1. Select .
 2. Press  to generate a default line.
 3. Press , , , and  to move the line up/down/left/right.
 4. Drag points of the line on the touch-screen to extend or shorten the line.
 5. Press .
-









Note

Only one line is supported.

The max. temperature, low temperature, and average temperature of line (e.g. L1) displays L1 Max: XX Min: XX Avg: XX. The real-time temperature trend chart will display.

4.3.3 Set Frame Rule

Steps

1. Select .
2. Press  to generate a default frame.
3. Press , , , and  to move the frame up/down/left/right.
4. Press  to enlarge the frame, and press  to contract the frame. Or you can drag the corner of the frame on touch-screen to enlarge or contract the frame.
5. Press .



The max. temperature, low temperature, and average temperature of frame (e.g. S1) displays S1 Max: XX Min: XX Avg: XX.

6. Repeat step 1 to 5 to set other frames.
-

Note

At most three frames are supported.

4.3.4 Delete Rules

Tap  and press  to clear all temperature rules. Or tap  and choose the single rule you want to delete.

4.4 Set Temperature Alarm

Set the alarm rules and the device will alarm when the temperature triggers the rule.





Before You Start





Set the palette.

Steps

1. Go to **Palettes** from the main menu.
2. Tap the icons to select an alarm rule type.

Table 4-2 Icon Description

Icon	Alarm Mode	Description
	Above Alarm	Set the alarm temperature, and the device alarms when target temperature is higher than rule temperature.
	Below Alarm	Set the alarm temperature, and the device alarms when target temperature is lower than rule temperature.
	Interval Alarm	Set the alarm temperature section (e.g., 90 °C to 150 °C), when target temperature is within the section (e.g., 100 °C), the device alarms.
	Insulation Alarm	Set the alarm temperature section (e.g., 90 °C to 120 °C), when target temperature is without the section (e.g., 70 °C or 125 °C), the device alarms.

3. Optional: Press  and  to select between upper limit and lower limit.
4. Press  and  to adjust the rule temperature.
5. Press  to exit.

Note

Go to **Local Settings** → **Image Settings** → **Audible Warning** to enable audible warning. The device will sound when alarm is triggered.

Chapter 5 Picture and Video

Insert memory card into the device, then you can record videos, capture snapshots, and mark and save important data.

Note

- Device does not support capturing or recording when the menu is shown.
- When the device is connected to your PC, it does not support capturing or recording.
- Go to **Local Settings** → **Device Settings** → **Filename Header**, you can set the filename header for capturing or recording to distinguish the files recorded in a specify scene.

Go to **Local Settings** → **Device Settings** → **Device Initialization** to initialize the memory card is needed.

5.1 Capture Picture

Steps

1. Go to **Local Settings** → **Capture Settings**.
2. Select **Capture Mode** to set the capture mode.

Single Capture Capture one picture for one time.

Continuous Capture Capture multiple pictures for one time. You can set the amount of pictures.

Timed Capture Device captures one picture after the specified time interval. You can set the time interval as needed.

3. Select **Picture Type** to set the picture type.

Offline Picture Select this type when analyzing the picture with the client software. You can add remarks on the picture.

Thermal Graphic Select this type for custom software development. Remark on the picture is not allowed.

4. Optional: You can enable flashlight to get clear pictures in dark environment.
5. Optional: Set the optical resolution as needed.
6. Press  to exit.
7. In the live view interface, pull the trigger to capture snapshot.

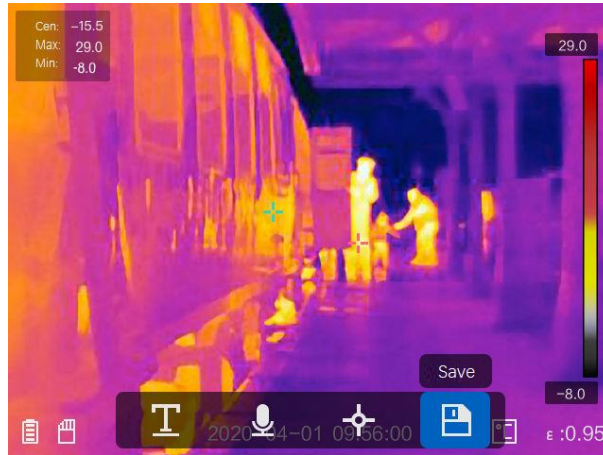

Figure 5-1 Capture Picture

8. The live view freezes and device displays the capture editing interface.
 - 1) Tap **T** to add text remarks. Tap the screen to show the keypad interface, enter the comment and confirm.
 - 2) Tap **🎤** to add voice remarks. Hold **🔴** to start recording and release the button to stop recording.
 - 3) Tap **⚙️** to add thermography rules. Refer to **Set Thermography Rule** for details.
 - 4) Tap **💾** or pull the trigger to save the snapshot.

Note

You can also press **👉** to quit the saving.

9. Refer to **Export Files** to export the snapshots.

5.2 Record Video

Steps



1. In the live view interface, pull the trigger to start recording. The recording icon and count down number display in the interface.



Figure 5-2 Record Video

2. When you finish, pull the trigger again to stop recording. The recording video will be saved automatically and exit.







Note

You can also press  or  to stop recording.



3. Refer to **Export Files** to export the snapshots.

5.3 View Recorded Files

Steps

1. Select  from the main menu.
2. Press , , , and  to select the video or snapshot.
3. Press  to view the file.

Note

- When you are viewing the videos or capture snapshots, you can switch the file by tapping  or .
 - When you are viewing the snapshots, You can tap  to play the sound. Refer to **Connect Bluetooth** to set the bluetooth.
 - For more information contained in capture snapshots or videos, you can install the thermography client to analyze them. You can get the thermography client software from the disk packed in box.
-

5.4 Export Files

Connect the device to your PC with supplied cable, you can export the recorded videos and

captured snapshots.

Steps

1. Open the cover of cable interface.
2. Connect the device to your PC with cable and open the detected disk.
3. Select and copy the videos or snapshots to PC to view the files.
4. Disconnect the device from your PC.



Note

For the first time connection, the driver will be installed automatically.

Chapter 6 Connect Bluetooth

You can record and hear the sound contained in the videos or images via bluetooth headsets after pairing the device with bluetooth headsets successfully.

Steps

1. Select  from the main menu.
2. Go to **Local Settings** → **Device Settings** → **Bluetooth**.
3. Tap on  to enable the bluetooth.

Note

You can also press  or **OK** to quit pairing.



The device will search the nearby enabled bluetooth headsets and pair them automatically.

Result

After pairing you can record and hear the sound via the headsets while recording and playing the video or image.

Chapter 7 Light Settings

7.1 Set LED Light

Go to **Local Settings** → **Device Settings** → **Light Supplement**. Tap  to enable LED light, or press  in the live view to enable/disable the LED light.

7.2 Set Laser

In the live view interface, hold  to enable/disable the laser light.

Caution

The laser radiation emitted from the device can cause eye injuries, burning of skin or inflammable substances. Before enabling the Light Supplement function, make sure no human or inflammable substances are in front of the laser lens.

Chapter 8 Hik-Thermal APP Connection

The device supports both Wi-Fi connection and WLAN hot spot. Connect the device to Hik-Thermal client software, and you can control the device via mobile client.

8.1 Connect via Wi-Fi

Before You Start

Download and install client software on your phone.

Steps

1. Go to **Local Settings** → **Device Settings** → **Wi-Fi**.
2. Tap to enable Wi-Fi, and the searched Wi-Fi will be listed as below.

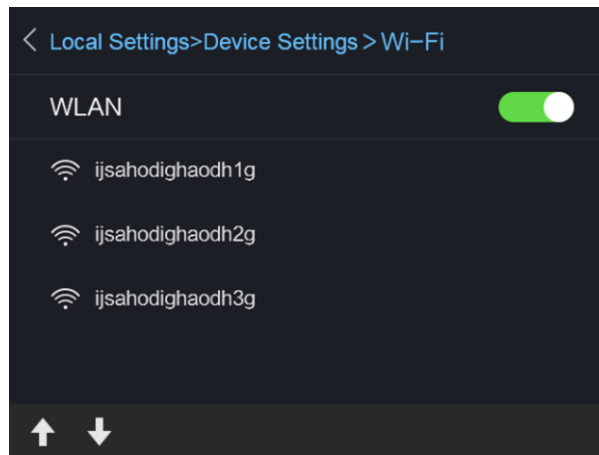

Figure 8-1 Wi-Fi List

3. Select Wi-Fi and enter password to show the keypad interface.

Note

DO NOT tap **enter** or **space**, or the password may be incorrect.

4. Tap **Close** to hide the keypad.
5. Tap **OK**.
6. Search the Hik-Thermal on App Store (iOS System) or Google Play™ (Android System) to download and install the app, or scan the QR code to download and install the app.



Android System



iOS System

7. Launch the app and follow the startup wizard to create, and register an account.
8. Add the device to online devices.

Result

You can view the live view, capture snapshots, and record videos via the client.

8.2 Connect via Hot Spot

Before You Start

Download and install client software on your phone.

Steps

1. Go to **Local Settings** → **Device Settings** → **Wi-Fi Hotspot Settings**.
2. Tap to enable WLAN hot spot function.
3. Tap **Set Hot Spot** to set the WLAN hot spot. The hot spot name and password display automatically.

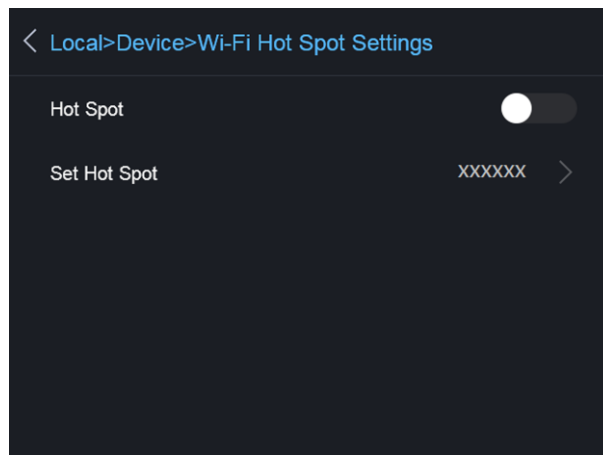

Figure 8-2 Set Hot Spot

4. Edit the hot spot name and password, show the keypad interface.

Note

DO NOT tap **enter** or **space**, and at least 8 characters, or the password may be incorrect.

5. Tap **Close** to hide the keypad.
6. Connect your phone to the WLAN Hot Spot of the device.
7. Search the Hik-Thermal on App Store (iOS System) or Google Play™ (Android System) to download and install the app, or scan the QR code to download and install the app.



Android System



iOS System

8. Launch the app and follow the startup wizard to create, and register an account.
9. Select Wi-Fi configuration in the software, enter the serial number of device to add the device.
Refer to the manual of client software for details.

Result

You can view the live view, capture snapshots, and record videos via the client.

Chapter 9 Maintenance

9.1 View Device Information

Go to **Local Settings** → **Device Information** to view the device information.

9.2 Set Date and Time

Steps

1. Go to **Local Settings** → **Device Settings** → **Time and Date**.
2. Set the date and time.
3. Press  to save and exit.

Note

Go to **Local Settings** → **Image Settings** → **Display Settings** to enable or disable time and date display.

9.3 Upgrade Device

Steps

1. Connect the device to your PC with cable and open the detected disk.
2. Copy the upgrade file and paste it to the root directory of the device.
3. Disconnect the device from your PC.
4. Reboot the device and then it will upgrade automatically. The upgrading process will be displayed in the main interface.

Note

After upgrading, the device reboots automatically. You can view the current version in **Local Settings** → **Device Information**.

9.4 Restore Device

Go to **Local Settings** → **Device Settings** → **Device Initialization** to initialize the device and restore default settings.

Chapter 10 Appendix

10.1 Common Material Emissivity Reference

Material	Emissivity
Human Skin	0.98
Printed Curcuit Board	0.91
Concrete	0.95
Ceramic	0.92
Rubber	0.95
Paint	0.93
Wood	0.85
Pitch	0.96
Brick	0.95
Sand	0.90
Soil	0.92
Cloth	0.98
Hard Paperboard	0.90
White Paper	0.90
Water	0.96

10.2 Device Command

Scan the following QR code to get device common serial port commands.

Note that the command list contains the commonly used serial port commands for Hikvision thermal cameras.



10.3 Device Communication Matrix

Scan the following QR code to get device communication matrix.

Note that the matrix contains all communication ports of Hikvision thermal cameras.





See Far, Go Further