

Druck DPI 800/802

Pressure indicator and
Pressure loop calibrator

User manual - K335

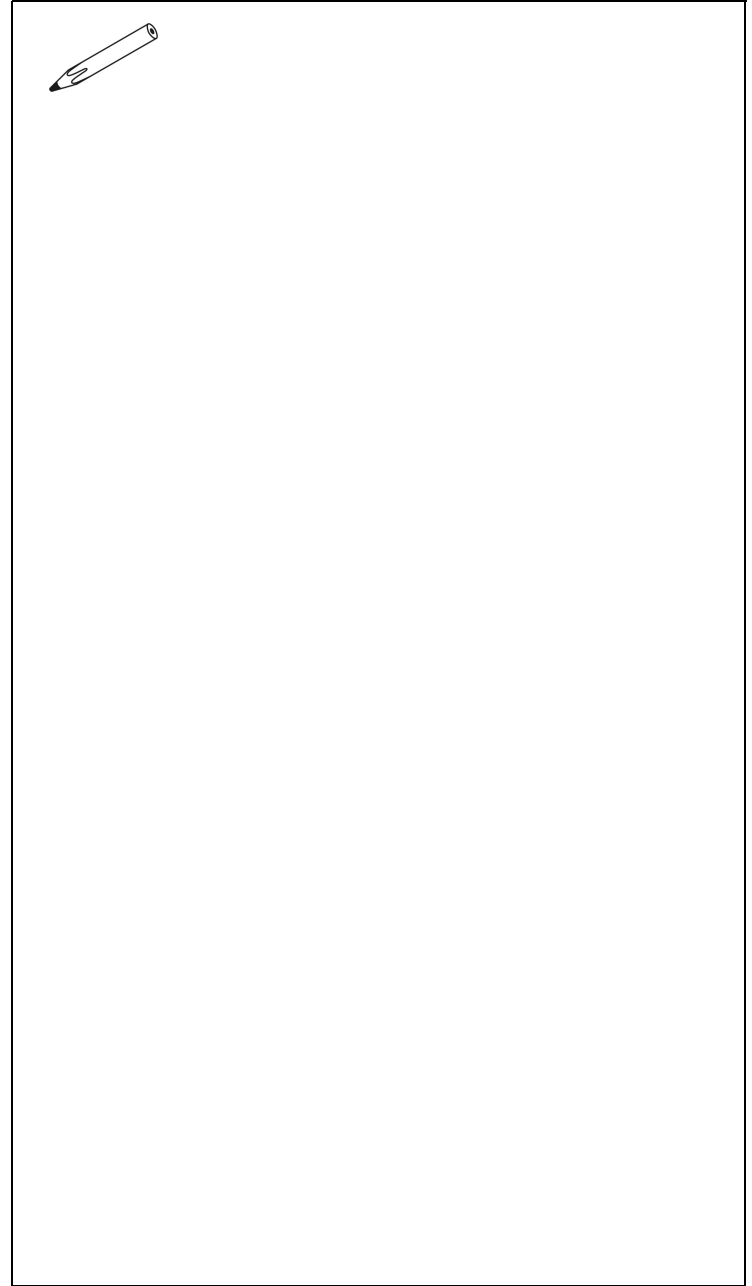

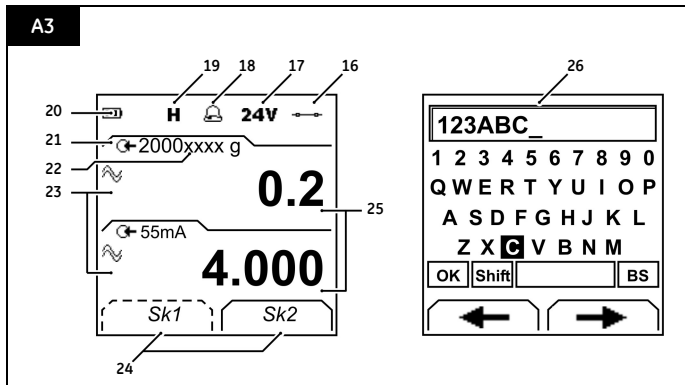
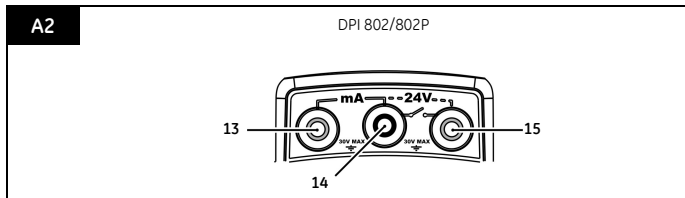
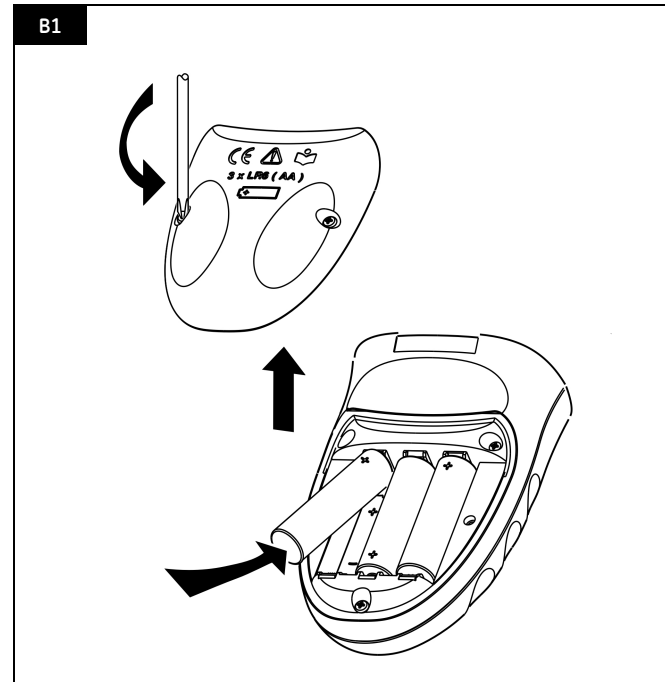
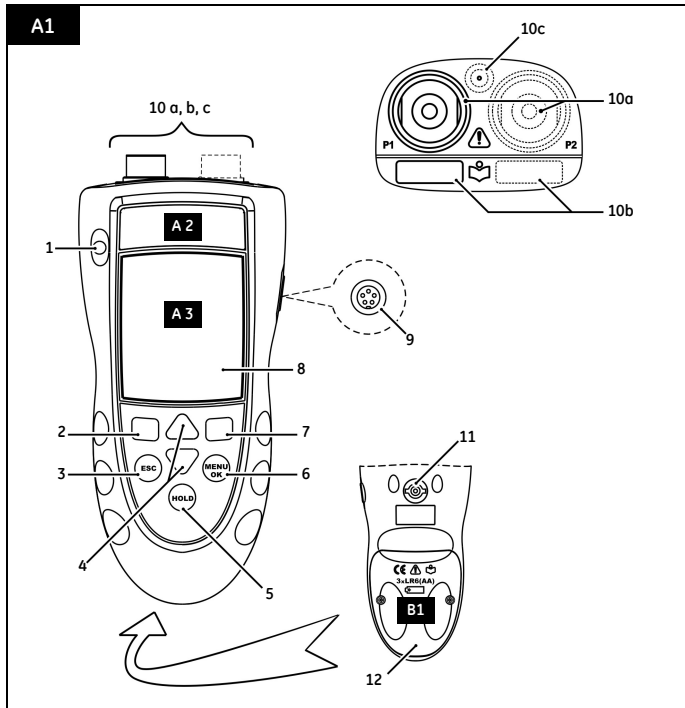

Table of Contents

Introduction	1
Safety	2
Marks and symbols on the instrument	2
To start	2
Location of items	2
Items on the display	3
Prepare the instrument	3
Power on or off	3
Set up the basic operation	3
Select a task (Measure)	4
Set up the settings	4
Edit functions	5
Operation	5
Pressure connections	5
Communications port connections	6
Measure pressure	6
Leak test	6
Switch test	7
Transmitter calibration	7
mA measurements	8
UPM Pressure measurements	8
Error indications	8
Maintenance	9
Clean the unit	9
Replace the batteries	9
Calibration	9
Before you start	9
Procedures (Pressure P1/P2)	10
Procedures (mA input)	10
Procedures (IDOS UMM)	10
Specification data	11
General	11
Pressure measurement	11
Electrical connectors (A2)	12
Customer service	Back cover

Introduction

The DPI 800 Pressure Indicator and DPI 802 Pressure Loop Calibrator are part of the Druck DPI 800 series of hand held instruments.

The DPI 800 series uses Intelligent Digital Output Sensor (IDOS) technology to give instant plug and play functionality with a range of Universal Measurement Modules (UMM). Example: the Universal Pressure Module (UPM).

The DPI 800/802 include these functions:

Function	DPI 800	DPI 802
Measure pressure *	Internal IDOS: P1 and/or P2**; External IDOS: UPM**	
Measure pressure difference ***	Difference (Δ) between: P1 and P2, or P1/P2 and a UPM	
Leak Test	Yes	
Communications port	IDOS or RS232	
Language selection	Yes	
Pressure units	25 (Fixed)	
Snapshot **	Up to 1000 displays with a date/time stamp	
Measure mA	No	0 - 55 mA
HART [®] resistor	No	Yes
V dc output	No	24 V
Switch test	No	Yes
Other functions	Hold, Maximum/Minimum/Average, Filter, Tare, Scaled values, Backlight, Alarm	

* Refer to "Specification data".

** Optional item

*** High range IDOS - Low range IDOS (if applicable)

© 2005 General Electric Company. All rights reserved.

Trademarks

All product names are trademarks of their respective companies.

Safety







Before you use the instrument, make sure that you read and understand all the related data. This includes: all local safety procedures, the instructions for the UMM (if applicable), and this publication.

WARNING

- Some liquid and gas mixtures are dangerous. This includes mixtures that occur because of contamination. Make sure that the instrument is safe to use with the necessary media.
- It is dangerous to ignore the specified limits for the instrument or to use the instrument when it is not in its normal condition. Use the applicable protection and obey all safety precautions.
- To prevent a dangerous release of pressure, isolate and bleed the system before you disconnect a pressure connection.
- Do not use the instrument in locations with explosive gas, vapor or dust. There is a risk of an explosion.
- DPI 802/802P only. To prevent electrical shocks or damage to the instrument, do not connect more than 30V between the terminals, or between the terminals and the ground (earth).

Before you start an operation or procedure in this publication, make sure that you have the necessary skills (if necessary, with qualifications from an approved training establishment). Follow good engineering practice at all times.

Safety - Marks and symbols on the instrument

	Complies with European Union directives		Warning - refer to the manual
	Read the manual		Battery
	Ground (Earth)	P1/P2	Identifies the pressure range connector
	ON/OFF		

MWP

The maximum working pressure for the connector.
Example: 2 x FS (FS = Full scale pressure)









REFERENCE

The connector is a reference port for reference pressure only. Refer to "Specification data".

The identification on each pressure connector includes the type of thread (1/8 NPT, G1/8 ...).

To start

To start - Location of items **A1** **A2**

Item	Description
1.	 On or off button.
2.	 Left-hand soft-key. Selects the function above it on the display (Item 24). Example: Edit
3.	ESC  Moves back one menu level. Leaves a menu option. Cancels the changes to a value.
4.	 Increases or decreases a value. Highlights a different item.
5.	HOLD  Holds the data on the display. To continue, press the HOLD button again.
6.	MENU OK  Shows the <i>Select Task</i> menu. Selects or accepts an item or value. Selects [✓] or cancels [] a selection
7.	 Right-hand soft-key. Selects the function above it on the display (Item 24). Example: Settings
8.	Display. Refer to A3
9.	SENSOR/PC  Communications port. Use to connect a Universal Measurement Module (UMM) or a RS232 cable.
10.	10a. IDOS pressure connector with identification marks. Refer to "Safety". 10b. Label to identify the pressure range for the associated IDOS pressure connector (P1/P2): Sealed gage (sg), gage (g), absolute (a). 10c. PTFE vent filter or a reference port connector. Refer to "Specification data".
11.	Connection point for some of the optional accessories. Refer to the datasheet.
12.	Battery compartment. Refer to B1.
13., 14., 15.	DPI 802/802P only. Terminals to measure current, to supply 24V source, and to do switch tests.

To start - Items on the display **A3**

Item	Description
16.	DPI 802/802P only. Task indication for the switch test. = switch closed = switch open Task indication for the leak test. <i>Refer to: Select Task (Table 2/3)</i>
17. 24V	DPI 802/802P only. The loop power supply is on. <i>Refer to: Select Task (Table 2/3)</i>
18.	The measured value satisfies one of the alarm conditions. <i>Refer to: Settings (Table 4)</i>
19. H	The data on the display is on hold. To continue, press the HOLD button again.
20.	Shows the battery level: 0 ... 100%.
21.	Identifies the type of data and the measurement range. = Input = IDOS input <i>Refer to: Select Task (Table 2/3)</i>
22. ... 23.	Identifies the settings applied to the input. <i>Refer to: Settings (Table 4)</i>
22. xxxx g	The units and the type of sensor (If applicable) OR a specified scale (xy).
23.	Shows the settings applied to the measured value (If applicable). = Filter = Maximum = Average = Tare = Minimum
24.	A soft-key function. To select an available function, press the soft-key below it. Example: = Move left = Move right
25.	The measured value or values applicable to the task selection.
26.	The <i>Edit</i> display to set up text labels (≤ 6 characters): <i>xy Scaling (Table 4).</i> OK = Accept the new text label Shift = Change the keys: 123ABC or _+abc = Add a space BS = Back space (Delete character)

To start - Prepare the instrument

Before you use the instrument for the first time:

- Make sure that there is no damage to the instrument, and that there are no missing items.
- Remove the plastic film that protects the display. Use the tag in the top right-hand corner.
- Install the batteries (refer to B1). Then re-attach the cover.

To start - Power on or off

To turn the instrument on or off, press (A1 - item [1]). The instrument does a self test and then shows the applicable data.

When the power is off, the last set of configuration options stays in memory. Refer to "Maintenance".

To start - Set up the basic operation

Use the *Set Up* menu to set up the basic operation of the instrument.

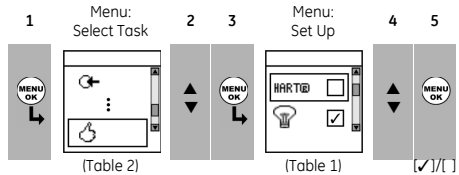

If there is additional data for a menu option, select *Settings* to see the values that are set up. If necessary, adjust the values.

Table 1: Menu options - Set Up

Options (If applicable)	Description
	DPI 802/802P only. To add a series resistor into the mA circuit. You can then use this instrument together with a HART® communicator to set up and calibrate HART® devices.
	To select and set up the backlight facility + timer. <i>Additional data: Select Settings </i>
	To select and set up the power off facility + timer. <i>Additional data: Select Settings </i>
	To show the battery level (%).
	To set the display contrast (%). Increases %, decreases %
	To set the time + date. The calibration facility uses the date to give service and calibration messages.
	To set the language option.
	To calibrate the instrument. <i>Additional data: Refer to "Calibration".</i>
	To select and show the applicable status data (Software Build, Calibration Due date, Serial Number, IDOS Information).

To start - Select a task (Measure)

When the instrument is set up (Table 1), use the *Select Task* menu to select the applicable task.

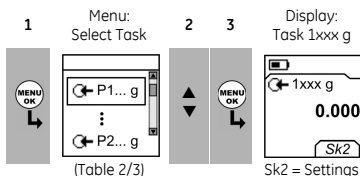

In Table 2/3, P1 and P2 are internal sensors, and IDOS is a Universal Measurement Module (UMM). If you attach a UMM to the communications port (A1 - item [9]), the *Select Task* menu shows the applicable IDOS options.

Table 2: Menu options - Select Task

Options (If applicable)	Description (* Optional item)
P...	An input measurement task (P1, P2*). The task includes the pressure range for the sensor.
ΔP...	An input measurement task to measure the pressure difference (Δ) between: P1 and P2*, or P1/P2* and a UPM*. ΔP = High range IDOS - Low range IDOS
mA	DPI 802/802P only. A mA measurement task.
mA(24V)	DPI 802/802P only. A mA measurement task + the loop power supply is on.
x	DPI 802/802P only. A switch test.
IDOS	UMM only. An IDOS measurement task.
	Pressure options only. A leak test.
	To set up the way the instrument works. <i>Additional data: Refer to: Set Up (Table 1).</i>

Table 3 shows all the one and two function operations that are available. If you attach a UMM, you can only use the options that include IDOS.

Table 3: Permitted 1 and 2 function operations

Function	P1	P2	ΔP... (Table 2)	IDOS
	(1)	(1)	(1)	(1)
mA	(1) (2)	(2)	(2)	(2)
mA(24V)	(1) (2)	(2)	(2)	(2)
x	(2)	(2)	(2)	(2)
	x (2)	(2)	x	(2)
IDOS	(1) (2)	(2)	x	x
P2	(1) (2)	x	x	(2)

= DPI 802/802P only

To start - Set up the settings

When the task is set up (Table 2/3), use the *Settings* menu to adjust the measurement operation.

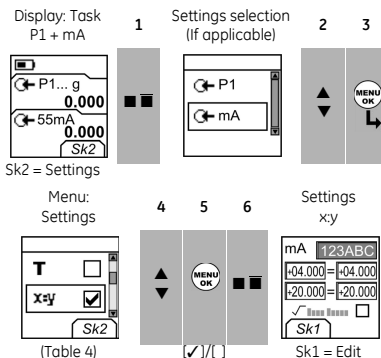

If there is additional data for a menu option, select *Settings* (■ ■) to see the values that are set up. If necessary, adjust the values. Refer to “Edit functions”

Table 4: (Part of table) Menu options - Settings

Options (If applicable)	Description
... Units	To select one of the fixed units of measurement (psi, mbar ...).
0.0	Gage sensors or sensors with differential operation (P1, P2, IDOS). A zero correction that makes the instrument read zero at local pressure.
	To include maximum, minimum and average values for the measurement task.
T	To select and set up a tare value for the measurement task (a specified value or the reading on the display). The instrument subtracts a positive tare value, and adds a negative tare value. <i>Additional data: Select Settings (■ ■)</i>
x:y	To select and set up a scale of values: One local scale for each measurement task (Maximum: 5). <i>Additional data (Example 1/2): Select Settings (■ ■)</i>

Table 4: (Part of table) Menu options - Settings

Options (If applicable)	Description
	To select and set up the filter values to give a smoother output for the measurement task: Band as a % of full scale (FS). The filter compares each new value with the previous value. If the new value is outside the band, it is not filtered. Low pass filter time constant in seconds. Increase the value to increase the damping factor. Additional data: Select Settings
	To select and set up the alarm values for the measurement task (maximum and minimum). Additional data: Select Settings
	Leak Test only. To set an applicable period for the leak test (Hours:Minutes:Seconds).

To start - Edit functions

Example 1) Set up a label for *xy* Scaling = %.

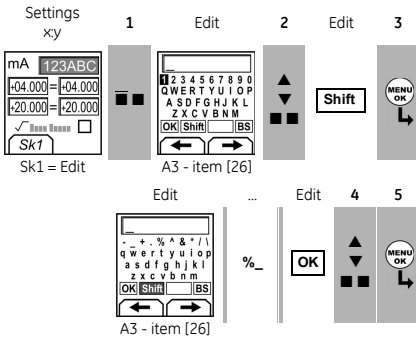

Example 2) Set up values for *xy* Scaling = 0 to 100%.

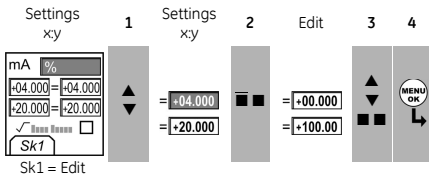

✓ = Flow scaling (mA, pressure only)

Operation

This section gives examples of how to connect and use the instrument. Before you start:

- Read and understand the "Safety" section.
- Do not use a damaged instrument.

Operation - Pressure connections

CAUTION: To prevent damage, do not apply torque to the body of the instrument. If available, use the flat faces on the pressure connector to hold the instrument in position.

Use an applicable method to seal the pressure connections, and then tighten to the applicable torque (Figure 1 and Table 5).

Note: If the instrument uses G1/8 connections, and the pressure is ≥ 1500 psi (100 bar), connection method (b) is mandatory.

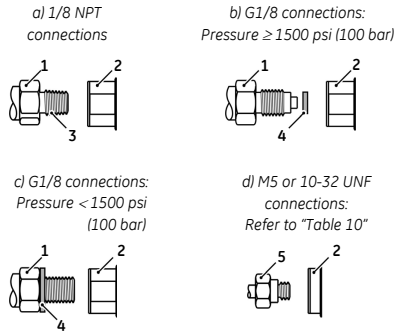

Figure 1: Connection methods

Table 5: Key to figure 1

Item	Description
1	Process connector. Maximum torque: 1/8 NPT: 26 lbf.ft (35 Nm) G1/8: 18.4 lbf.ft (25 Nm)
2	Applicable instrument pressure connector (Table 10)
3	(1/8 NPT only) Thread with an applicable sealant
4	(G1/8 only) Applicable bonded seal
5	Reference port connector: M5 or 10-32 UNF (Table 10) Maximum torque: 1.5 lbf.ft (2 Nm)

Operation - Communications port connections

Use the communications port (A1 - item [9]) to attach an IDOS Universal Measurement Module (UMM). When you attach the cable from a UMM (Figure 8), the instrument automatically changes the menus to give you all the applicable options (Table 2/3).

Operation - Measure pressure

To measure the pressure or the pressure difference (if there are two IDOS pressure ranges).

1. Connect the instrument (Figure 2) and, if necessary, adjust the *Set Up* (Table 1).
2. Select an applicable pressure task from *Select Task* (Table 2/3) and, if necessary, adjust the *Settings* (Table 4).
3. If necessary, do a zero correction (Table 4).
4. Before you disconnect the instrument, isolate and bleed the system.

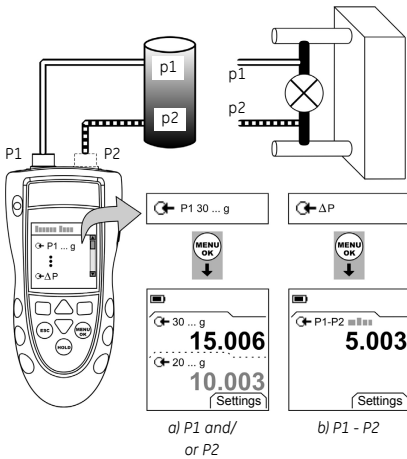

Figure 2: Example configuration - Measure pressure

The examples in Figure 2 show:

- how to measure one or two pressures in a system
- how to measure pressure difference

Note: ΔP = High range IDOS - Low range IDOS. If Pressure (p_2) > Pressure (p_1), the result is negative.

Operation - Leak test

To do a leak test on a pressure system:

1. Connect the instrument (Figure 3) and, if necessary, adjust the *Set Up* (Table 1).
2. Select an applicable leak test from *Select Task* (Table 2/3) and, if necessary, adjust the *Settings* (Table 4).
3. Set the period for the leak test (Table 4).
4. If necessary, do a zero correction (Table 4).
5. To start the leak test, select Start (■). When the test is finished, the instrument calculates the leak rate in the applicable units/minute.
6. Before you disconnect the instrument, isolate and bleed the system.

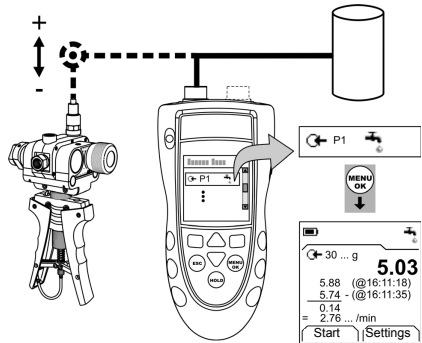

Figure 3: Example configuration - Leak test

Operation - Switch test

DPI 802/802P only. To do tests on a pressure switch:

1. Connect the instrument (Figure 4) and, if necessary, adjust the *Set Up* (Table 1).
2. Select the applicable switch test from *Select Task* (Table 2/3) and, if necessary, adjust the *Settings* (Table 4). The display shows the switch condition (open or closed) in the top right-hand corner.
3. If necessary, do a zero correction (Table 4).
4. Slowly apply pressure to the system until the switch changes condition (open or closed).
5. Slowly release the pressure until the switch changes condition again. The display shows the pressure values to open and close the switch.
6. To do the test again, press **ESC** to reset the values.
7. Before you disconnect the instrument, isolate and bleed the system.

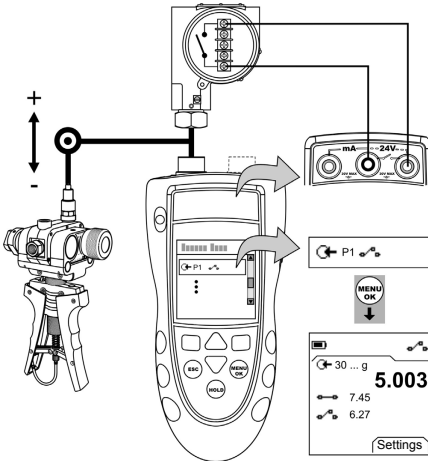

Figure 4: Example configuration - Switch test

Operation - Transmitter calibration

DPI 802/802P only. To calibrate a transmitter:

1. Connect the instrument (Figure 5 or Figure 6) and, if necessary, adjust the *Set Up* (Table 1).
2. Select the applicable calibration task from *Select Task* (Table 2/3) and, if necessary, adjust the *Settings* (Table 4).
3. If necessary, do a zero correction (Table 4).

4. For each calibration point, apply an applicable pressure and wait for the pressure system to stabilize.
5. Before you disconnect the instrument, isolate and bleed the system.

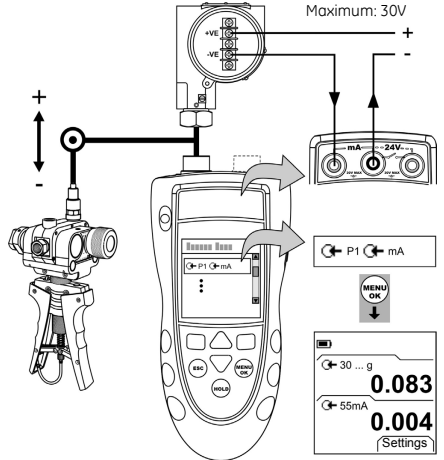

Figure 5: Example configuration - Transmitter calibration with external loop power

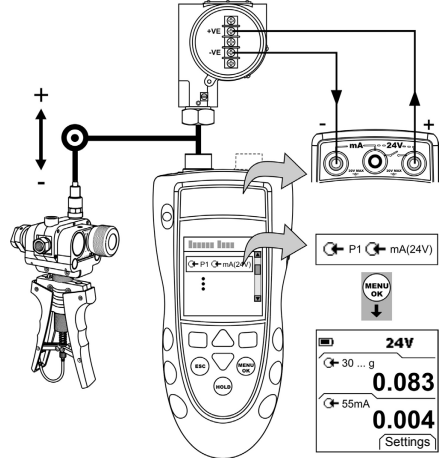

Figure 6: Example configuration - Transmitter calibration with internal loop power

Operation - mA measurements

DPI 802/802P only. To measure a current:

1. Connect the instrument (Figure 7) and, if necessary, adjust the *Set Up* (Table 1).
2. Select the applicable mA task from *Select Task* (Table 2/3) and, if necessary, adjust the *Settings* (Table 4).

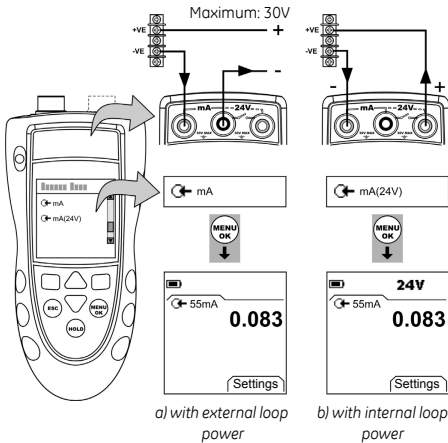

Figure 7: Example configuration - mA measurement

Operation - UPM Pressure measurements

Read all the instructions supplied with the UPM and then use the specified procedures to connect it (Figure 8).

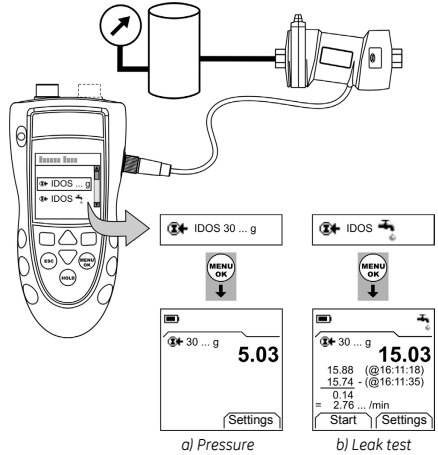

Figure 8: Example configuration - Pressure measurement with a UPM

When the connections are complete, make the necessary IDOS selections (Table 2/3). Then use the same procedures as specified for the P1/P2 connections.

If you re-attach a UPM, the instrument uses the same measurement units that you used before. The instrument keeps a record for the last 10 modules.

Operation - Error indications

If the display shows <<<< or >>>> :

- Make sure that the range is correct.
- Make sure that all the related equipment and connections are serviceable.

Maintenance

This section gives procedures to maintain the unit in a good condition. You must return the unit to the supplier for all repairs.

Maintenance - Clean the unit

Clean the case with a moist, lint-free cloth and a weak detergent. Do not use solvents or abrasive materials.

Maintenance - Replace the batteries **B1**

To replace the batteries, refer to B1. Then re-attach the cover.

Make sure that the time and date are correct. The calibration facility uses the date to give service and calibration messages.

All the other configuration options stay in memory.

Calibration

Note: GE can provide a calibration service that is traceable to international standards.

We recommend that you return the instrument to the manufacturer or an approved service agent for calibration.

If you use an alternative calibration facility, make sure that it uses these standards.

Calibration - Before you start

To do an accurate calibration, you must have:

- the calibration equipment specified in Table 6.
- a stable temperature environment: $70 \pm 2^\circ\text{F}$ ($21 \pm 1^\circ\text{C}$)

Table 6: Calibration equipment

Function	Calibration equipment
Pressure	An applicable pressure standard (primary or secondary) with a total uncertainty of 0.01% reading or better.
mA	mA calibrator. Accuracy: Refer to Table 9.

Before you start the calibration, make sure that the time and date on the instrument are correct (Table 1).

Selection sequence:

► Select Task (Table 2) ► Set Up (Table 1) ► Calibration ►

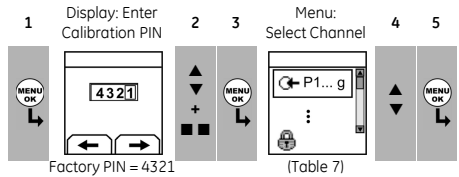

Table 7: Calibration options

Options (If applicable)	Description (* Optional item)
P...	To calibrate the specified IDOS pressure input (P1 or P2*).
IDOS ...	UMM only. To calibrate the specified IDOS UMM. Refer to the user manual for the IDOS UMM.
mA	DPI 802/802P only. To calibrate the mA input.
	<i>Calibration Due:</i> To set the date of the next calibration for the instrument. After the specified calibration date, there is a warning message. There is a selection box to stop the warning.
	To change the calibration PIN (Personal Identification Number).

When you select a channel, the display shows the applicable instructions to complete the calibration.

When the calibration is complete, select *Calibration Due* and set the new calibration date for the instrument.

Calibration - Procedures (Pressure P1/P2)

1. Connect the instrument to the pressure standard (Figure 2).
2. Let the equipment get to a stable temperature (minimum: 30 minutes since the last power on).
3. Use the calibration menu (Table 7) to do a two-point calibration (Zero and +FS) or a three-point calibration (-FS, Zero and +FS). Refer to Table 8. The display shows the applicable instructions to complete the calibration.

Table 8: Calibration pressures

Ranges: g/d	Nominal applied pressure psi (mbar)		
	-FS †	Zero	+FS
≤ 10.0 psi (700 mbar)	-FS	0	+FS
> 10.0 psi (700 mbar)	-13.1 (-900)	0	+FS

† For a three-point calibration, do not apply more than -90% of the specified FS for the unit.

Ranges: a	Nominal applied pressure psi (mbar)	
	Zero	+FS
5.00 psi (350 mbar)	< 0.02 (1.0)	+FS
30.0 psi (2 bar)	< 0.07 (5.0)	+FS
100.0 psi (7 bar)	< 0.29 (20.0)	+FS
300.0 psi (20 bar)	< 0.73 (50.0)	+FS

Ranges: sg	Nominal applied pressure	
	Zero	+FS
≥ 5000 psi (350 bar)	Use atmospheric pressure as zero.	+FS

4. To make sure that the calibration is correct, select the applicable pressure task (Table 2) and apply these pressure values:
 - Ranges g/d or sg: 0, 20, 40, 60, 80, 100 (%FS)
Then: Go back to 0 in the same steps.
Then (three-point calibration only):
-20, -40, -60, -80, -100 (%FS)
Then: Go back to 0 in the same steps.
 - Ranges a: 0, 20, 40, 60, 80, 100 (%FS)
Then: Go back to 0 in the same steps.

5. Make sure that the error is in the specified limits:

- Standard accuracy:

The specified accuracy (refer to "Specification data") includes an allowance for temperature changes, reading stability for one year, and the uncertainty of the standard used for calibration.

In step 4, make sure that the error between the applied pressure and the reading on the unit is not more than 0.015% FS.

- Premier precision:

The specified precision (refer to "Specification data") includes an allowance for temperature changes and the uncertainty of the standard used for calibration.

In step 4, make sure that the error between the applied pressure and the reading on the unit is not more than the specified value for Premier precision.

Calibration - Procedures (mA input)

1. DPI 802/802P only. Connect the instrument to the calibration equipment (Figure 7).
2. Let the equipment get to a stable temperature (minimum: 5 minutes since the last power on).
3. Use the calibration menu (Table 7) to do a three-point calibration (-FS, Zero and +FS). The display shows the applicable instructions to complete the calibration.
4. To make sure that the calibration is correct, select the applicable mA task (Table 2) and apply these values:
 - mA: -55, -40, -24, -18, -12, -6, 0 (short circuit)
Then: 0, 6, 12, 18, 24, 40, 55.
5. Make sure that the error is in the specified limits (Table 9).

Table 9: mA input error limits

Applied mA	Calibrator error (mA)	Permitted DPI 800/802 error (mA)
±55	0.0022	0.005
±40	0.0018	0.004
±24	0.0014	0.003
±18	0.0004	0.003
±12	0.0003	0.002
±6	0.0002	0.002
0 (Short circuit)	-	0.001

Calibration - Procedures (IDOS UMM)

Refer to the user manual for the IDOS UMM.

When the calibration is complete, the instrument automatically sets a new calibration date in the UMM.

Specification data

All accuracy statements are for one year.

Specification - General

Languages	English [Default]
Operating temperature	14 ... 122°F (-10 ... 50°C)
Storage temperature	-4 ... 158°F (-20 ... 70°C)
Humidity	0 to 90% without condensation (Def Stan 66-31, 8.6 cat III)
Shock/Vibration	BS EN 61010:2001; Def Stan 66-31, 8.4 cat III

EMC	BS EN 61326-1:1998 + A2:2001
Safety	Electrical - BS EN 61010:2001; Pressure Equipment Directive - Class: Sound Engineering Practice (SEP); CE Marked
Size (L: W: H)	Maximum: 7.5 x 3.3 x 2.0 in (190 x 85 x 50 mm)
Weight	19 oz (530 g)
Power supply	3 x AA alkaline batteries
Duration (Measure)	P1: ≈ 50 hours P1 + mA: ≈ 5 hours (24 V Source at 12 mA)

Specification - Pressure measurement

The % full scale (FS) statements for Standard accuracy and Premier precision are only applicable if there is a regular zero correction by the IDOS instrument.

Ranges: Gage and differential operation (g/d), sealed gage (sg), absolute (a)	Type	Standard Accuracy * % FS	Premier Precision † % FS	Notes
+/- psi: 0.36 (+/- mbar: 25)	g/d	0.1	0.03	1/2
+/- psi: 1, 3, 5, 10 (+/- mbar: 70, 200, 350, 700)	g/d	0.075	0.03	1/2
psi: -15 to [15 or 30] (bar: -1 to [1 or 2])	g/d	0.05	0.01	1/2
psi: -15 to [50, 100, 150, or 300] (bar: -1 to [3.5, 7, 10, or 20])	g/d	0.05	0.01	1/3
psi: 500, 1000, 1500, 2000, 3000 (bar: 35, 70, 100, 135, 200)	g/d	0.05	0.01	1/3
psi: 5 (mbar: 350)	a	0.1	-	2
psi: 30 (bar: 2)	a	0.075	-	2
psi: 100, 300 (bar: 7, 20)	a	0.075	-	3
psi: 5000, 10000 (bar: 350, 700)	sg	0.05	-	3

* Standard accuracy is for 32 ... 122°F (0 ... 50°C);

Stability: 1 year

† Premier precision is for 65 ... 82°F (18 ... 28°C);

Stability: ≤10 psi (700 mbar) = 0.02% of reading/Year

Stability: >10 psi (700 mbar) = 0.01% of reading/Year

Premier precision for 41 ... 113°F (5 ... 45°C):

≤10 psi (700 mbar): 0.075% FS

>10 psi (700 mbar): 0.014% FS

Notes:

1. Reference port media: Non-corrosive, dry gas
2. + port media: Non-corrosive, non-conductive liquid or Non-corrosive, dry gas
3. + port media: Media applicable to stainless steel

Table 10: DPI 800 series pressure connections

Ranges	Pressure connections (One IDOS range)	Pressure connections (Two IDOS ranges)
g/d: ≤ 30 psi g (2 bar g) Standard or Premier	1/8 NPT female (+ port) + 1/8 NPT female reference port OR G1/8 female (+ port) + G1/8 female reference port	Two 1/8 NPT female (+ port) + 10-32 UNF reference port OR Two G1/8 female (+ port) + M5 reference port
g/d: > 30 psi g (2 bar g) Standard only	1/8 NPT female (+ port) OR G1/8 female (+ port)	Two 1/8 NPT female (+ port) OR Two G1/8 female (+ port)
g/d: > 30 psi g (2 bar g) Premier only	1/8 NPT female (+ port) + 10-32 UNF reference port OR G1/8 female (+ port) + M5 reference port	Two 1/8 NPT female (+ port) + 10-32 UNF reference port OR Two G1/8 female (+ port) + M5 reference port
sg or a: all ranges	G1/8 female (+ port) OR 1/8 NPT female (+ port)	Two 1/8 NPT female (+ port) OR Two G1/8 female (+ port)

Table 11: Maximum pressure (+ port)

Ranges: g/d, sg, a	MWP	Maximum transient / intermittent pressure
≤ 5 psi (350 mbar)	2 × FS	4 × FS
> 5 psi (350 mbar)	1.2 × FS	2 × FS

Table 12: Maximum pressure (Reference port)

Ranges: g/d only	MWP
≤ 5 psi (350 mbar)	2 × FS
10 to 15 psi (700 mbar to 1 bar)	1.2 × FS
≥ 30 psi (2 bar)	30 psi (2 bar)

Specification - Electrical connectors (A2)

Range (Measure)	0 to ±55 mA
Accuracy	0.02% of reading + 3 counts
Temperature coefficient 14 ... 50°F, 86 ... 122°F (-10 ... 10°C, 30 ... 50°C)	0.0011% FS / °F (0.002% FS / °C)
Switch detection	Open and closed, 2 mA current.
Loop power output	24 V ± 10%
HART® resistor	250 Ω (menu selection)
Connectors (A2)	Three 0.16 in (4 mm) sockets

Customer Service

Visit our web site: www.gesensing.com