



Easidew Portable Standard Version User's Manual



97065 Issue 16.3
October 2019

Please fill out the form(s) below for each instrument that has been purchased.

Use this information when contacting Michell Instruments for service purposes.

Analyzer	
Code	
Serial Number	
Invoice Date	
Location of Instrument	
Tag Number	

Analyzer	
Code	
Serial Number	
Invoice Date	
Location of Instrument	
Tag Number	

Analyzer	
Code	
Serial Number	
Invoice Date	
Location of Instrument	
Tag Number	



Easidew Portable

For Michell Instruments' contact information please go to
www.michell.com

© 2019 Michell Instruments

This document is the property of Michell Instruments Ltd and may not be copied or otherwise reproduced, communicated in any way to third parties, nor stored in any Data Processing System without the express written authorization of Michell Instruments Ltd.

Contents

Safety	v
Electrical Safety	v
Pressure Safety	v
Toxic Materials	v
Repair and Maintenance	v
Calibration	v
Safety Conformity	v
Abbreviations.....	vi
Warnings	vi
1 INTRODUCTION	1
2 INSTALLATION	2
3 OPERATION	3
3.1 General Operation	3
3.2 Atmospheric or Line Pressure Measurements	4
3.3 Measuring Dew Points Below -40°C (-40°F).....	5
3.4 User Controls	6
3.5 4–20 mA Output Socket Wiring.....	7
4 GOOD MEASUREMENT PRACTICE	8
5 MAINTENANCE	11
5.1 Calibration	11
5.2 Sensor / Battery Replacement	11
5.3 Filter Cartridge Replacement	13
5.4 Checking the Easidew Portable Electronics Calibration	13
5.5 List of Spares	13
5.6 Troubleshooting.....	14

Figures

<i>Figure 1</i>	<i>Interchangeable Gas Inlet/Outlet Fittings</i>	<i>4</i>
<i>Figure 2</i>	<i>User Controls</i>	<i>6</i>
<i>Figure 3</i>	<i>Jack Plug Wiring.....</i>	<i>7</i>
<i>Figure 4</i>	<i>Material Permeability Comparison</i>	<i>8</i>
<i>Figure 5</i>	<i>2-Wire Connection - View Showing Rear of Connector Terminal Block.....</i>	<i>13</i>

Appendices

Appendix A	Technical Specifications.....	16
Appendix B	Quality, Recycling & Warranty Information.....	18
Appendix C	Decontamination Declaration.....	20

Safety

The manufacturer has designed this equipment to be safe when operated using the procedures detailed in this manual. The user must not use this equipment for any other purpose than that stated. Do not apply values greater than the maximum value stated.

This manual contains operating and safety instructions, which must be followed to ensure the safe operation and to maintain the equipment in a safe condition. The safety instructions are either warnings or cautions issued to protect the user and the equipment from injury or damage. Use qualified personnel and good engineering practice for all procedures in this manual.

Electrical Safety

The instrument is designed to be completely safe when used with options and accessories supplied by the manufacturer for use with the instrument. The instrument is powered by an internally mounted rechargeable battery. The input power supply voltage limits for the battery charger supplied with the instrument are 90 to 264 V AC, 47/63 Hz.

NOTE: No battery charger unit other than that supplied with the instrument should be used.

NOTE: Do not allow the battery to fully discharge.

Pressure Safety

DO NOT permit pressures greater than the safe working pressure to be applied to the instrument. The specified safe working pressure is 20 barg (290 psig). Refer to the Technical Specifications in Appendix A.

Toxic Materials

The use of hazardous materials in the construction of this instrument has been minimized. During normal operation it is not possible for the user to come into contact with any hazardous substance which might be employed in the construction of the instrument. Care should, however, be exercised during maintenance and the disposal of certain parts.

Repair and Maintenance

The instrument must be maintained either by the manufacturer or an accredited service agent. Refer to www.michell.com for details of Michell Instruments' worldwide offices contact information.

Calibration

The recommended calibration interval for the Easidew Portable is one year, unless otherwise specified by Michell Instruments Ltd. The instrument should be returned to the manufacturer, Michell Instruments, or one of their accredited service agents for re-calibration (go to www.michell.com for contact information).

Safety Conformity

This product meets the essential protection requirements of the relevant EU directives. Further details of applied standards may be found in the product specification.

Abbreviations

The following abbreviations are used in this manual:

AC	alternating current
atm	pressure unit (atmosphere)
barg	pressure unit (=100 kP or 0.987 atm) gauge
°C	degrees Celsius
°F	degrees Fahrenheit
dp	dew point
ft	feet
kg	kilogram
lb	pound
mA	milliampere
m	meter
mm	millimeter
MPa	megapascal
NI/min	normal liters per minute
psig	pound(s) per square inch (gauge)
scfh	standard cubic feet per hour
µm	micrometer
Ω	ohm
V	Volts

Warnings

The following general warnings listed below are applicable to this instrument. They are repeated in the text in the appropriate locations.



Where this hazard warning symbol appears in the following sections, it is used to indicate areas where potentially hazardous operations need to be carried out.

1 INTRODUCTION

The Easidew Portable comprises an Easidew sensor fitted into a sample block with an integrated filter cartridge, and Legris push fittings on the gas inlet and outlet. The measured dew point from the sensor is shown on the clear red LED display on the front panel of the instrument.

The Easidew Portable can be supplied with either °C or °F dew-point measurement units.

A 4-20 mA analog output is provided for connection to a chart recorder, data-logger or computer system, so dew-point trends can be analyzed over time.

The electronics are housed in a rugged Peli case, providing NEMA 6 protection when the lid is closed. The case is supplied with a lifetime guarantee.

The Easidew Portable is powered by a rechargeable NiMH battery pack, giving between 12 and 16 hours of measurement time from a full charge. The instrument is delivered complete with a universal battery charger stored in the lid. It takes 16 hours to fully charge the battery pack, during which time the instrument can be switched on or off. The charger is suitable to connect power to the instrument indefinitely, but it is recommended to allow the battery pack to go through a full charge-discharge cycle at least once per month.

All Michell Ceramic Moisture Sensors are subject to a 13-point calibration, where their performance is characterized against a fundamental reference hygrometer. This process, and subsequent quality testing, ensures that all sensors behave optimally before they are used in the field. Each Easidew Portable is supplied with a calibration certificate traceable to national standards (NIST) from Michell Instruments accredited laboratory.

2 INSTALLATION

On delivery, please check that all the following standard components are present in the packing box:

- Easidew Portable
- 2m of 6mm O/D PTFE tube
- Battery charger
- Mains lead
- 3 pole ¼" jack plug (inside lid) - for analog output connections
- Certificate of calibration

Before using the Easidew for the first time it is recommended that the battery pack is charged for a minimum of 12 hours.

3 OPERATION



Maximum operating pressure is 20 barg (290 psig).

It is important that the gas fittings are correctly tightened, and any tubing is secure in the push fittings before use.

Failure to do so will affect the instrument's pressure rating.

3.1 General Operation

To operate the Easidew Portable, follow these instructions:

1. Ensure that all gas fittings are fully tightened before use.
2. Gas under test should be restricted to flow rates between 1 and 5 NI/min (2 and 10.6 scfh) and pressures from atmospheric to 2 MPa (20 barg (290 psig)).
3. Connect the sample gas supply line to the instrument **Gas In** port.
4. Connect the sample gas vent line to the instrument **Gas Out** port.
5. Switch the instrument on. The display will begin to change as the sensor responds to the applied dew point.
6. Allow the gas to flow until the display shows a stable reading. Typically this would be around 15 to 30 minutes for spot checks at dew points of -40°C (-40°F) and above.
7. Switch the unit off and disconnect the sample lines.

NOTE: Filters are essential for potentially dirty/contaminated gases – the fitted filter should be checked before and after use and replaced regularly - as required.

3.2 Atmospheric or Line Pressure Measurements

The Easidew Portable is supplied with two labelled, interchangeable, gas inlet/outlet fittings.

Number	Description
1	4mm free flow fitting
2	0.4mm restricted fitting

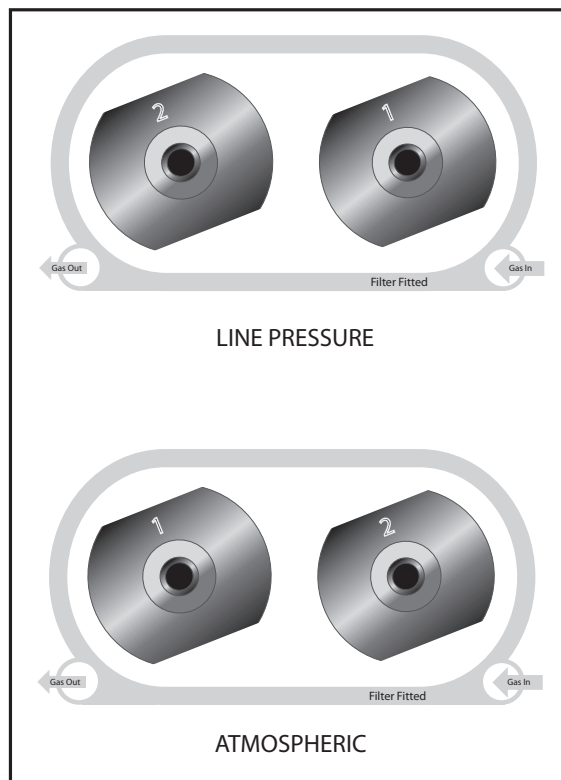

Figure 1 Interchangeable Gas Inlet/Outlet Fittings

In order to perform measurements at line pressure, the restricted fitting should be on the gas outlet port.

To perform measurements at atmospheric pressure, the restricted fitting should be on the gas inlet port.



The Gas In port is ALWAYS on the right hand side.

3.3 Measuring Dew Points Below -40°C (-40°F)

Due to the significantly lower levels of moisture present at dew points of this level, the response times of the sensor will be significantly increased. The table below offers an approximate guide to the times taken for the instrument to stabilize at a given dew point (from a starting point of 10°Cdp (50°Fdp) ambient):

Target Dew Point		T100 Response Time (mins)
°C	°F	
-30	-22	15
-40	-40	30
-50	-58	60
-60	-76	180

The Easidew sensor fitted to the Easidew Portable is designed and calibrated to measure dew points as low as -100°C (-148°F). However, due to the large internal volume of the sample block, the hygroscopic nature of the built-in filter, and the potential of the gas fittings to trap moisture at very low dew points, we recommend that the Easidew Portable is not used to measure dew points below -60°C (-76°F). Suitable alternative solutions in our range would be the Easidew Online, Pura fixed installations, MDM300 Portable, or our cooled mirror range of instruments.

3.4 User Controls

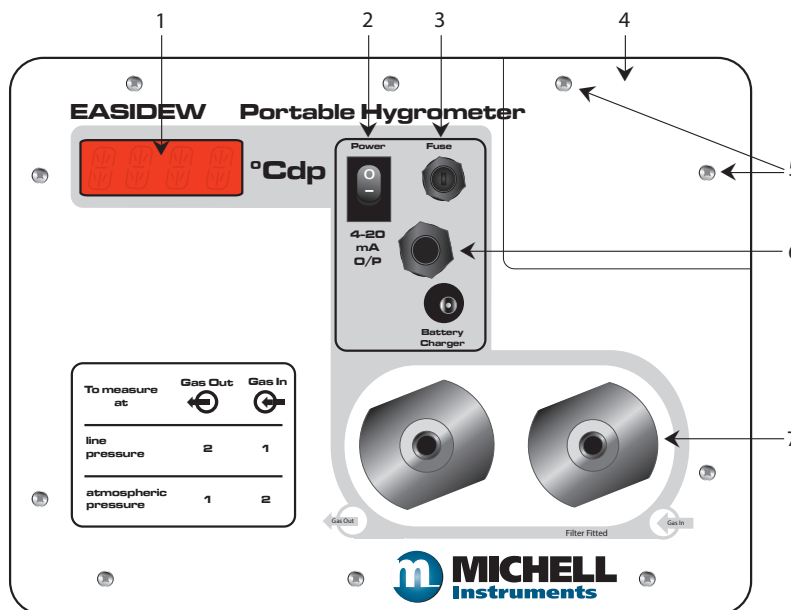

Figure 2 User Controls

1	Digital Display	Indicates the measured dew point in °C from -100 to +20 (-148 to +68°F). Under certain conditions the following error messages may be displayed: ErrL = Sensor under range ErrH = Sensor over range Err I = Sensor fault or sensor disconnected
2	Power Switch	Switches the Easidew Portable ON or OFF.
3	Fuse	This 1A quick blow fuse provides protection for the display electronics in the event of a fault with the charger or battery pack. Another protection fuse is located on the display PCB.
4	NiMH Battery Pack	Located in the top right hand corner of the instrument, it can be accessed by removing two screws (5). The battery pack can be recharged using the supplied charger, via the battery-charging socket. See Section 5.5 for troubleshooting information. The battery pack will charge if the instrument is switched ON or OFF.
6	Analog Output Socket	The Easidew portable features an analog output socket that provides a linear 4-20 mA current loop, scaled to -100 to +20°C (-148 to +68°F) dew point. This allowed the instrument to be connected to a chart recorder, data logger or PC to enable dew-point trends to be analyzed over time. For wiring information see Section 3.5.
7	Gas Fittings	The Easidew Portable can be used for measurements at line pressure (up to 20 barg (290 psig)) or atmospheric pressure. Legris push fittings are supplied for use with 6mm OD PTFE tubing. There is a 32mm particulate filter (99.5% removal of 0.1 micron particles) fitted as standard under the Gas In port position.

3.5 4–20 mA Output Socket Wiring

The Easidew Portable provides a linear 4-20 mA output scaled from -100 to +20°C.

The socket accepts a 3 pole ¼" jack plug (supplied) and should be wired as shown below:

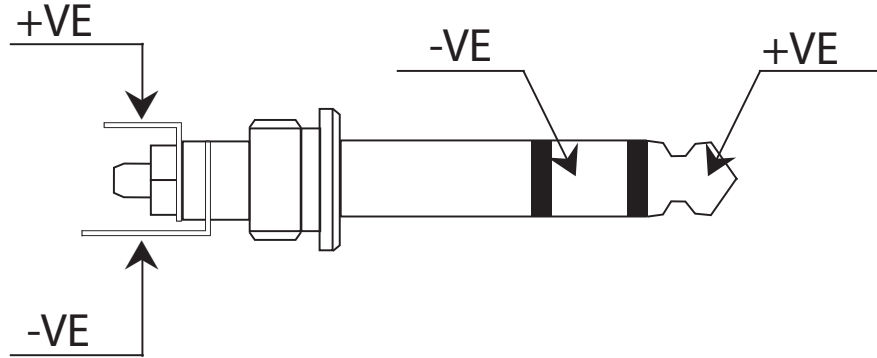

Figure 3 Jack Plug Wiring

4 GOOD MEASUREMENT PRACTICE

Ensuring reliable and accurate moisture measurements requires the correct sampling techniques, and a basic understanding of how water vapor behaves. This section aims to explain the common mistakes and how to avoid them.

Sampling Materials – Permeation and Diffusion

All materials are permeable to water vapor since water molecules are extremely small compared to the structure of solids, even including the crystalline structure of metals. The graph above demonstrates this effect by showing the increase in dew point temperature seen when passing very dry gas through tubing of different materials, where the exterior of the tubing is in the ambient environment.

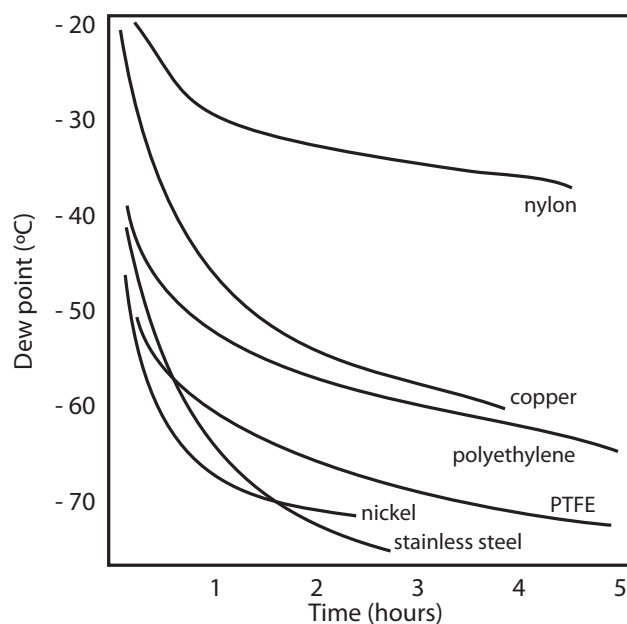

Figure 4 *Material Permeability Comparison*

What this demonstrates is the dramatic effect that different tubing materials have on the humidity levels of a gas passed through them. Many materials contain moisture as part of their structure and when these are used as tubing for a dry gas the gas will absorb some of the moisture. Always avoid using organic materials (e.g. rubber), materials containing salts and anything which has small pores which can easily trap moisture (e.g. nylon).

As well as trapping moisture, porous sampling materials will also allow moisture vapor to ingress into the sample line from outside. This effect is called diffusion and occurs when the partial water vapor pressure exerted on the outside of a sample tube is higher than on the inside. Remember that water molecules are very small so in this case the term 'porous' applies to materials that would be considered impermeable in an everyday sense – such as polyethylene or PTFE. Stainless steel and other metals can be considered as practically impermeable and it is surface finish of pipework that becomes the dominant factor. Electropolished stainless steel gives the best results over the shortest time period.

Take into consideration the gas you are measuring, and then choose materials appropriate to the results you need. The effects of diffusion or moisture trapped in materials are more significant when measuring very dry gases than when measuring a sample with a high level of humidity.

Temperature and Pressure effects

As the temperature or pressure of the environment fluctuates, water molecules are adsorbed and desorbed from the internal surfaces of the sample tubing, causing small fluctuations in the measured dew point.

Adsorption is the adhesion of atoms, ions, or molecules from a gas, liquid, or dissolved solid to the surface of a material, creating a film. The rate of adsorption is increased at higher pressures and lower temperatures.

Desorption is the release of a substance from or through the surface of a material. In constant environmental conditions, an adsorbed substance will remain on a surface almost indefinitely. However, as the temperature rises, so does the likelihood of desorption occurring.

Ensuring the temperature of the sampling components is kept at consistent levels is important to prevent temperature fluctuation (i.e. through diurnal changes) continually varying the rates of adsorption and desorption. This effect will manifest through a measured value which increases during the day (as desorption peaks), then decreasing at night as more moisture is adsorbed into the sampling equipment.

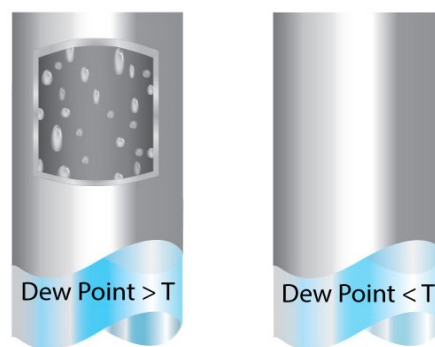

If temperatures drop below the sample dew point, water may condense in sample tubing and affect the accuracy of measurements.

Maintaining the temperature of the sample system tubing above the dew point of the sample is vital to prevent condensation. Any condensation invalidates the sampling process as it reduces the water vapor content of the gas being measured. Condensed liquid can also alter the humidity elsewhere by dripping or running to other locations where it may re-evaporate.

Although ambient pressure does not change drastically in a single location, the gas sample pressure does need to be kept constant to avoid inconsistencies introduced by adsorption or desorption. The integrity of all connections is also an important consideration, especially when sampling low dew points at an elevated pressure. If a small leak occurs in a high-pressure line, gas will leak out; however, vortices at the leak point and a negative vapor pressure differential will also allow water vapor to contaminate the flow.

Theoretically flow rate has no direct effect on the measured moisture content, but in practice it can have unanticipated effects on response speed and accuracy. An inadequate flow rate may:

- Accentuate adsorption and desorption effects on the gas passing through the sampling system.
- Allow pockets of wet gas to remain undisturbed in a complex sampling system, which will then gradually be released into the sample flow.
- Increase the chance of contamination from back diffusion. Ambient air that is wetter than the sample can flow from the exhaust back into the system. A longer exhaust tube can help alleviate this problem.
- Slow the response of the sensor to changes in moisture content.

An excessively high flow rate can:

- Introduce back pressure, causing slower response times and unpredictable changes in dew point
- Result in a reduction in depression capabilities in chilled mirror instruments by having a cooling effect on the mirror. This is most apparent with gases that have a high thermal conductivity such as hydrogen and helium.

System design for fastest response times

The more complicated the sample system, the more areas there are for trapped moisture to hide. The key pitfalls to look out for here are the length of the sample tubing and dead volumes.

The sample point should always be as close as possible to the critical measurement point to obtain a truly representative measurement. The length of the sample line to the sensor or instrument should be as short as possible. Interconnection points and valves trap moisture, so using the simplest sampling arrangement possible will reduce the time it takes for the sample system to dry out when purged with dry gas.

Over a long tubing run, water will inevitably migrate into any line, and the effects of adsorption and desorption will become more apparent.

Dead volumes (areas which are not in a direct flow path) in sample lines, hold onto water molecules which are slowly released into the passing gas. This results in increased purge and response times, and wetter than expected readings. Hygroscopic materials in filters, valves (e.g. rubber from pressure regulators) or any other parts of the system can also trap moisture.

Plan your sampling system to ensure that the sample tap point and the measurement point are as close as possible to avoid long runs of tubing and dead volumes.

Filtration

All trace moisture measurement instruments and sensors are by their nature sensitive devices. Many processes contain dust, dirt or liquid droplets. Particulate filters are used for removing dirt, rust, scale and any other solids that may be in a sample stream. For protection against liquids, a coalescing or membrane filter should be used. The membrane provides protection from liquid droplets and can even stop flow to the analyser completely when a large slug of liquid is encountered, saving the sensor from potentially irreparable damage.

5 MAINTENANCE

Routine maintenance of the Easidew Portable is confined to regular re-calibration of the internal, removable Easidew sensor and replacement of the filter cartridge.

5.1 Calibration

The calibration of the internal sensor is traceable to national standards. For this reason it should only be calibrated in an accredited, e.g. UK *United Kingdom Accreditation Service (UKAS)* or US *National Institute of Standards and Technology (NIST)* standards laboratory. If these facilities do not exist it is recommended that the sensor is returned to the manufacturer, Michell Instruments, or an approved agent. A calibration certificate bearing a seven-point calibration is issued with each sensor.

In most applications, annual re-calibration ensures that the stated accuracy of the Easidew sensor is maintained.

5.2 Sensor / Battery Replacement

To remove the sensor, or battery pack:

1. Ensure instrument is switched off and that the battery charger, current output and any sampling components are also disconnected.
2. Remove and retain the 10 cross-head screws from the top plate.
3. Lift the small battery pack cover in the top right corner of the instrument. A small flat bladed screwdriver may be required to gently pry the edges of the cover if it has become stuck to the waterproof seal underneath. Removing this cover first will make it easier to lift the entire top panel out of the instrument.
4. Lift the top plate of the instrument out of the case. Disconnect the battery pack before removing the top plate completely to prevent it from straining on the attached cable. If only replacing the battery pack, do not follow the next two steps.
5. Undo the screw from the centre of the sensor connecting plug and pull off the connector.
6. Unscrew the sensor from the block.

Fitting the replacement is simply a reversal of the above procedure. When fitting a new sensor it may be necessary to change the alignment of the GDSN connector (see next page).

If the front panel prevents the connector from fitting onto the sensor, follow the instructions below:

- Completely unscrew the cable gland on the GDSN connector to release the cable tension.

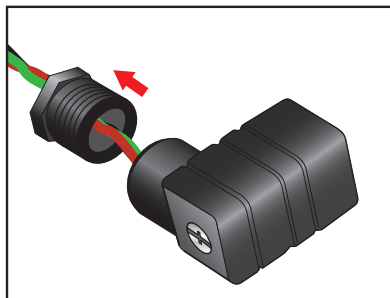

- Remove the locking screw from the back of the connector (retaining the metal O-ring).

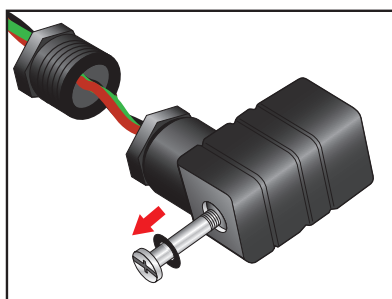

- Remove the connector block using a small screwdriver.

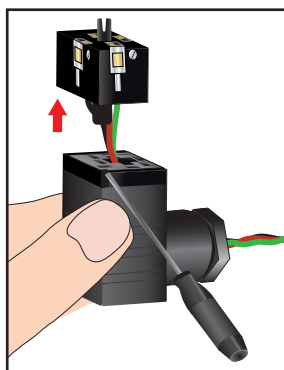

- Rotate the connector block and push it back into the connector housing. Take care not to trap any wires against the hole for the locking screw.

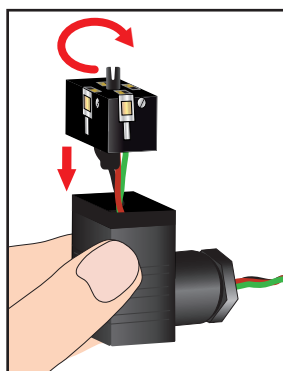

- Replace the locking screw and cable gland.

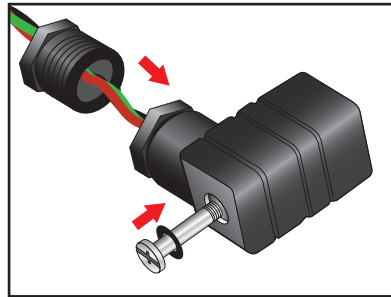

5.3 Filter Cartridge Replacement

Unscrew the gas inlet fitting to reveal the filter, which can then simply be removed for checking or replacement.

5.4 Checking the Easidew Portable Electronics Calibration

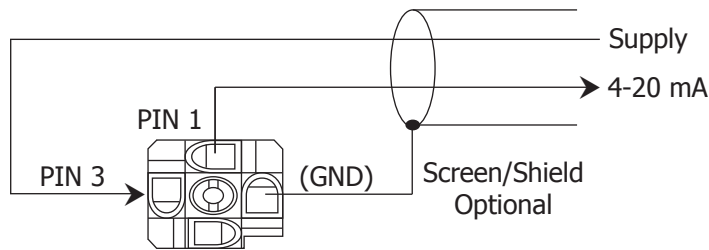

Figure 5 2-Wire Connection - View Showing Rear of Connector Terminal Block

To verify the display electronics are within calibration a 4-20mA current source can be connected in place of the sensor.

At 4 mA the display should show $-100.0^{\circ}\text{Cdp} \pm 0.5^{\circ}\text{C}$ ($-148^{\circ}\text{Fdp} \pm 0.9^{\circ}\text{F}$)

At 20 mA the display should show $+20.0^{\circ}\text{Cdp} \pm 0.5^{\circ}\text{C}$ ($+68^{\circ}\text{Fdp} \pm 0.9^{\circ}\text{F}$)

If the displayed values are outside of this range, please contact Michell Instruments' Service Department.

5.5 List of Spares

P/N	Description
SSF-PF-10PK	Pack of 10 particulate filter cartridges
EAP-BAT	Replacement battery pack
EAP-CHR	Replacement battery charger

5.6 Troubleshooting

Symptom	Cause	Actions
Display shows "ErrI"	<p>Sensor disconnected or sensor tile / sensor thermistor fault.</p> <p>NOTE: This error is normally displayed during the first few seconds while the instrument is starting up.</p>	<p>Check sensor cable is securely connected inside instrument.</p> <p>Check instrument electronics with 4-20mA source.</p> <p>Exchange sensor.</p>
Display shows "ErrL"	<p>Sensor reading under-range.</p> <p>Sensor current signal < 4mA</p> <p>Sensor tile open circuit.</p>	<p>Check instrument electronics with 4-20mA source.</p> <p>Exchange sensor.</p>
Display shows "ErrH"	<p>Sensor reading over-range.</p> <p>Sensor current signal > 20mA</p> <p>Sensor tile short circuit.</p>	<p>Sensor may have been exposed to saturation conditions or liquid contamination. Check that filter and sensor guard are clean and dry.</p> <p>If liquid water has contacted sensor, or sensor block, then disassemble and dry thoroughly. After drying, it is recommend to purge assembled instrument with very dry (-75°Cdp (-103°Fdp) / 1ppm_v moisture) air for 12 to 24 hours.</p> <p>Exposure to other contaminants can cause lasting damage and may require sensor to be exchanged.</p> <p>Check instrument electronics with 4-20mA source.</p>
Display flickers on and off.	Battery voltage low.	Connect charger.

Appendix A

Technical Specifications

Appendix A Technical Specifications

Performance	
Measurement Technology	Impedance
Measurement Ranges	
Spot Checks	-40 to +20°Cdp (-40 to +68°Fdp)
Online	-100 to -40°Cdp (-148 to -40°Fdp)
Accuracy	±2°Cdp (±3.6°Fdp)
Run time	12 - 16 hours
Charge time	16 hours for maximum charge
Flow Rate	1 to 5 NI/min (2.1 to 10.5 scfh)
Electrical Input/Output	
Output	4-20 mA current maximum load resistance 400 Ω
Power Supply	Rechargeable NiMH battery pack, charger included
Operating Conditions	
Operating Temperature	-20 to +50°C (-4 to +122°F)
Storage Temperature	-40 to +75°C (-40 to +167°F)
Operating Pressure	Up to 2 MPa (20 barg (290 psig))
Mechanical Specifications	
Display	Flush mounted 3.5 digit red LED
Case	Yellow propylene with charger, sample tubing and output connector stored in the lid
Weight	4kg (8.8lbs) total weight
Enclosure Rating Case Closed	NEMA Type 6
Sample Connections	Push fit pneumatic fittings for gas inlet/outlet
Sample Block	Stainless steel, fully self-contained sample system using a standard drop-in cartridge
Filter Cartridge	Removes 99.5% of particles ≥ 0.3 μm supplied with cartridge installed. Spare cartridges are available (part no: SSF-PF-10PK)
Interchangeability	Sensor is fully interchangeable with other Easidew products
Sample Tubing	2m (6.6ft) of 6mm O/D PTFE supplied

Appendix B

Quality, Recycling & Warranty Information

Appendix B Quality, Recycling & Warranty Information

Michell Instruments is dedicated to complying to all relevant legislation and directives. Full information can be found on our website at:

www.michell.com/compliance

This page contains information on the following directives:

- ATEX Directive
- Calibration Facilities
- Conflict Minerals
- FCC Statement
- Manufacturing Quality
- Modern Slavery Statement
- Pressure Equipment Directive
- REACH
- RoHS3
- WEEE2
- Recycling Policy
- Warranty and Returns

Appendix C

Decontamination Declaration

Appendix C Decontamination Declaration

Decontamination Certificate

IMPORTANT NOTE: Please complete this form prior to this instrument, or any components, leaving your site and being returned to us, or, where applicable, prior to any work being carried out by a Michell engineer at your site.

Instrument			Serial Number	
Warranty Repair?	YES	NO	Original PO #	
Company Name			Contact Name	
Address				
Telephone #			E-mail address	
Reason for Return /Description of Fault:				
Has this equipment been exposed (internally or externally) to any of the following? Please circle (YES/NO) as applicable and provide details below				
Biohazards			YES	NO
Biological agents			YES	NO
Hazardous chemicals			YES	NO
Radioactive substances			YES	NO
Other hazards			YES	NO
Please provide details of any hazardous materials used with this equipment as indicated above (use continuation sheet if necessary)				
Your method of cleaning/decontamination				
Has the equipment been cleaned and decontaminated?			YES	NOT NECESSARY
Michell Instruments will not accept instruments that have been exposed to toxins, radio-activity or bio-hazardous materials. For most applications involving solvents, acidic, basic, flammable or toxic gases a simple purge with dry gas (dew point <-30°C) over 24 hours should be sufficient to decontaminate the unit prior to return. Work will not be carried out on any unit that does not have a completed decontamination declaration.				
Decontamination Declaration				
I declare that the information above is true and complete to the best of my knowledge, and it is safe for Michell personnel to service or repair the returned instrument.				
Name (Print)			Position	
Signature			Date	



F0121, Issue 2, December 2011

NOTES:



<http://www.michell.com>