

Druck DPI 104

Digital pressure indicator

User manual - K394

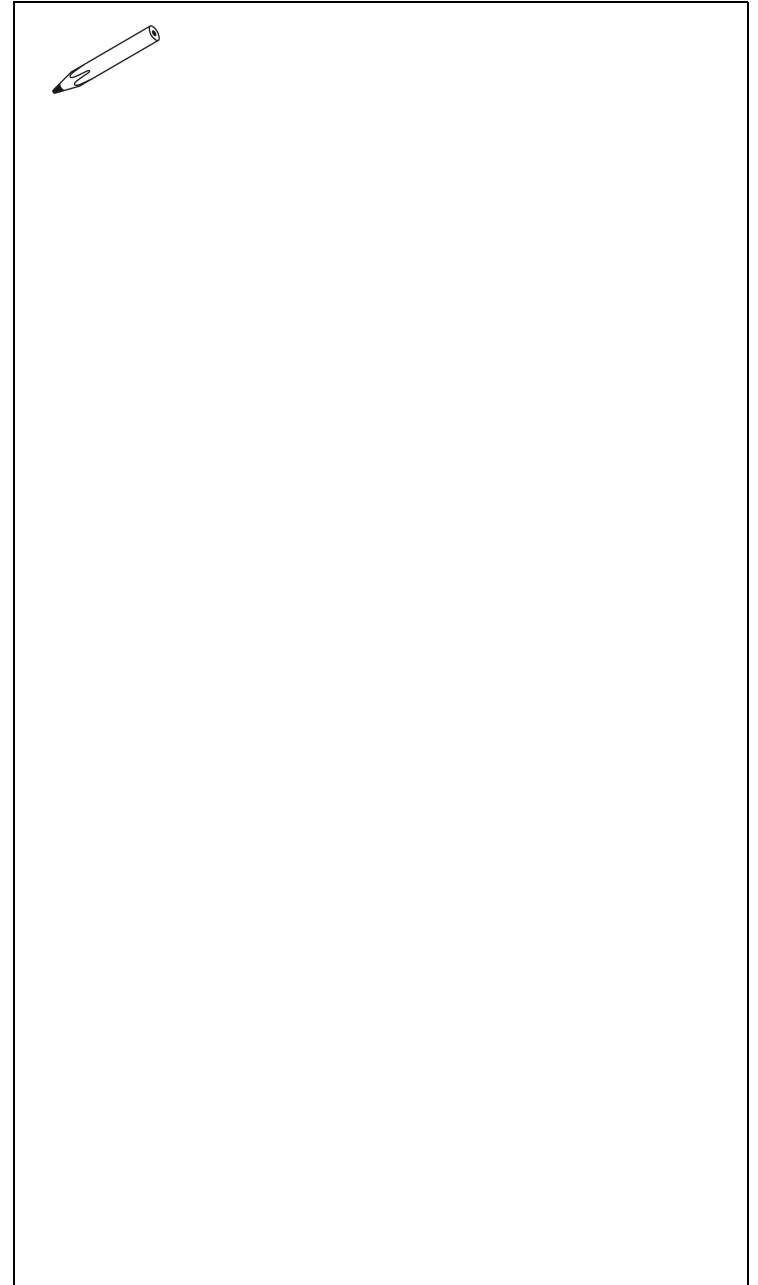

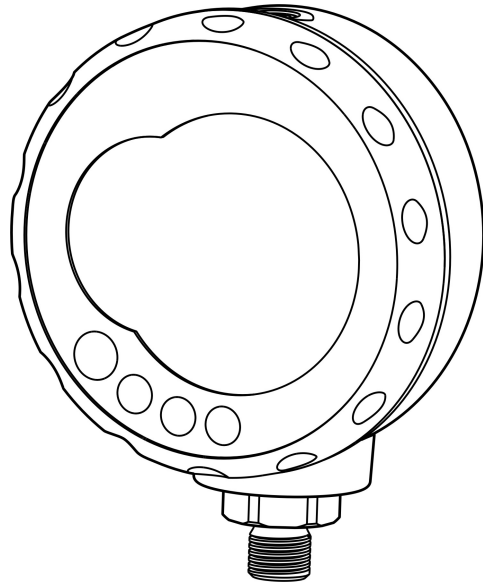
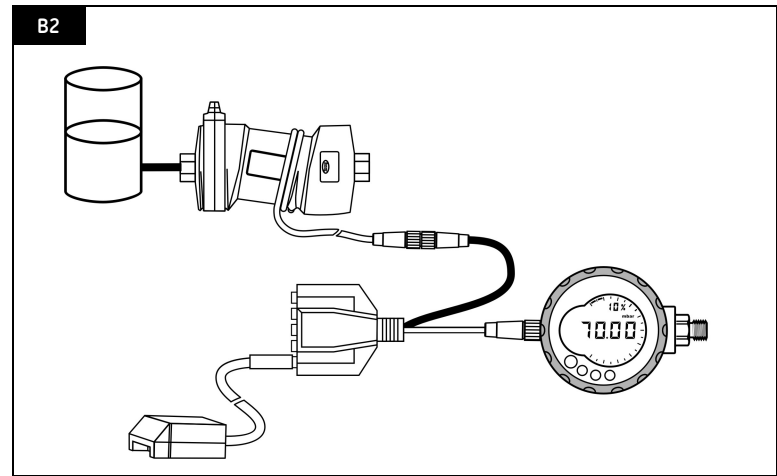
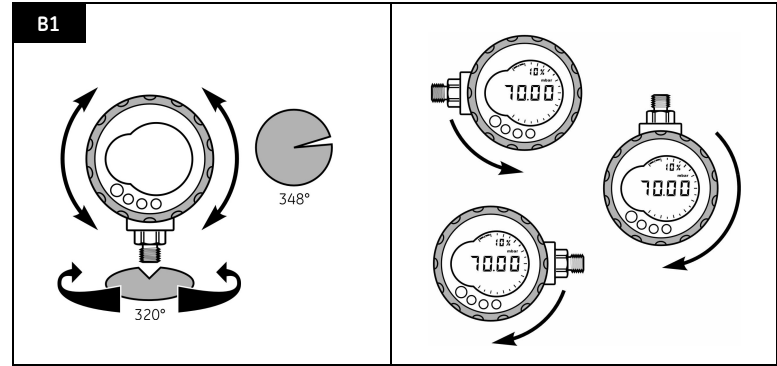
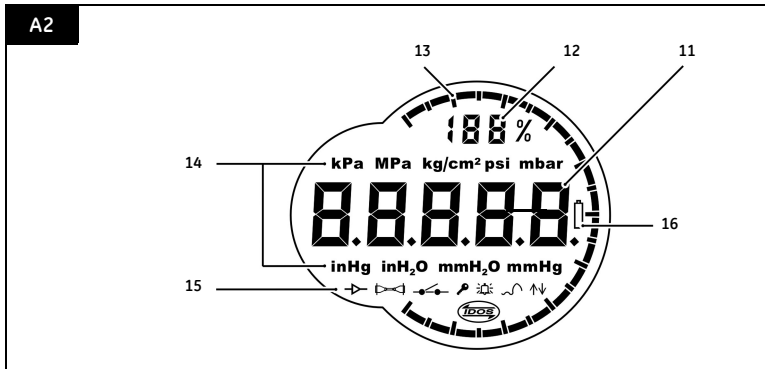
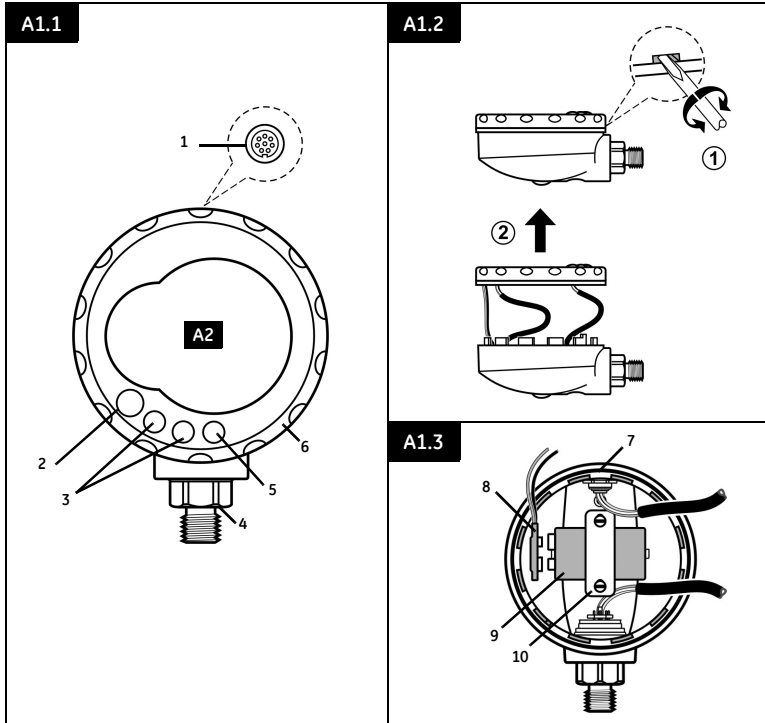

Table of Contents

Introduction	1
Safety	1
Marks and symbols on the DPI 104	1
To Start	2
Location of items	2
Items on the display	2
Prepare the instrument	2
Power on or off	2
Menu operation	3
Installation	4
Battery	4
Position	4
Pressure connections	4
Electrical connections	4
Operation	5
Menu: Set units	5
Menu: Set tare	5
Menu: Monitor maximum/minimum	5
Menu: Monitor a pressure switch	6
Menu: Calibration	6
Menu: Set low/high alarm	6
Menu: Supply voltage output (Vout)	6
Menu: Set Vout scale factor	7
Menu: Set automatic power OFF	7
Menu: Set lock code	7
Menu: Set scan rate	7
Menu: Monitor external IDOS	7
Menu: Set FSO low/high registers	8
Set up a DPI 104 network	8
Error indications	8
Maintenance	9
Replace the batteries	9
Restore the original configuration	9
Calibration	9
Equipment and conditions	9
Procedures	9
Specification data	11
General	11
Pressure measurement	11
Electrical	11
Customer service	Back cover

© 2005 General Electric Company. All rights reserved.

Trademarks

All product names are trademarks of their respective companies.

Introduction

The Druck DPI 104 is a digital pressure indicator that measures the pressure of liquid, gas or vapour and shows the pressure value on a liquid crystal display (LCD). It also has the Intelligent Digital Output Sensor (IDOS) technology to use data from a Universal Pressure Module (UPM).

The DPI 104 includes these functions:

Function
* Measure pressure - Accuracy: 0.05% full scale (FS)
Large 5-digit main display with 11 pressure units
Adjustable Full Scale Output (FSO)
20 segment analogue dial in increments of 5% FSO (large division marks = 10% increments).
2.5 digit percentage indicator (0-100% FSO)
8-pin connector port: For RS232, **IDOS UPM, external power supply
Alarm output for high/low pressure conditions
Switch input to monitor an external pressure switch
Analogue voltage output (Vout): 0 - 5 Vdc
Other functions: Maximum/minimum, tare, Vout scale factor, automatic power off

* Refer to "Specification data".

** Optional item

Safety

Before you use the DPI 104, make sure that you read and understand all the related data. This includes: all local safety procedures, and this publication.

WARNING

- **Some liquid and gas mixtures are dangerous. This includes mixtures that occur because of contamination. Make sure that the DPI 104 is safe to use with the necessary media.**
- **It is dangerous to ignore the specified limits for the DPI 104 or to use the DPI 104 when it is not in its normal condition. Use the applicable protection and obey all safety precautions.**
- **To prevent a dangerous release of pressure, isolate and bleed the system before you disconnect a pressure connection.**
- **Do not use the DPI 104 in locations with explosive gas, vapour or dust. There is a risk of an explosion.**

Before you start an operation or procedure, make sure that you have the necessary skills (if necessary, with qualifications from an approved training establishment). Follow good engineering practice at all times.





Safety - Marks and symbols on the DPI 104



Complies with European Union directives

To Start













To start - Location of items **A1**

Item	Description
1.	8-pin connector for external power supplies, RS232/UPM connections and signal input/output.
2.	<ul style="list-style-type: none"> Power on button Menu mode: Press for 2 seconds to show the first menu option. To move down the menu structure, press again and again, or press and hold. Reject or stop the change to a value. In Maximum/minimum mode. Press to show the maximum and minimum values since the last reset.   = maximum   = minimum
3.	In menu mode: <ul style="list-style-type: none"> On/OFF selection Increase/decrease a value Move the decimal left/right
4.	Pressure sensor and connector with 320° of turn: gauge (g), absolute (a) or Sealed gauge (sg). Refer to "Specification data".
5.	<ul style="list-style-type: none"> In menu mode: <ul style="list-style-type: none"> Accepts a menu selection Shows the next menu level Accepts a value In <i>Tare mode</i>: Tare the pressure value on the display. In Maximum/minimum mode. Reset the maximum/minimum values.
6.	Display bezel with 348° of turn.
7.	O-ring.
8.	Battery connector
9.	Battery: 9 V Alkaline (supplied but not installed). Refer to "Installation".
10.	Battery clamp with two screws.

To start - Items on the display **A2**

Item	Description
11.	5-digit main display.
12.	2.5-digit percentage indicator (0-100% FSO). $\%FSO = [Applied\ Pressure / (FSO\ High - FSO\ Low)] * 100$
13.	20 segment analogue dial in increments of 5% FSO (large division marks = 10% increments). $\%FSO = [Applied\ Pressure / (FSO\ High - FSO\ Low)] * 100$
14.	The units of measurement: kPa, MPa, kg/cm ² , psi, mbar, bar, mmHg, mmH ₂ O, mH ₂ O, inH ₂ O, inHg

Continued

Item	Description
15.	Mode indication.
	Voltage output (Vout) mode - On.
	RS232 connection. The data transmit/receive function is active.
	Switch mode - On. To monitor an external pressure switch.  = switch closed  = switch open
	Menu Lock mode - On. To restrict access to the menu functions.
	Alarm mode - On. The symbol flashes when the measured value satisfies one of the alarm conditions.   = High alarm   = Low alarm
	Maximum/minimum mode - On.
	IDOS UPM mode - On. To monitor pressure from a UPM
16.	Low battery power indication: Battery life ≤ 15%.

To start - Prepare the instrument

Before you use the instrument for the first time:

- Make sure that there is no damage to the instrument, and that there are no missing items.
- Install the battery (refer to "Installation"). Then re-attach the display bezel [A1: item 6].

To start - Power on or off

Press the buttons in the sequence shown below.

- Power on sequence:

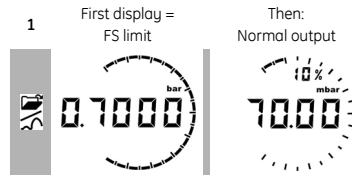



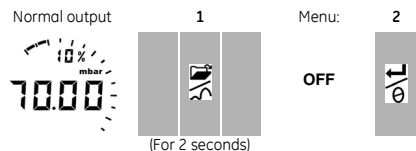









































- Power off sequence:



When the power is off, the last set of configuration options stays in memory.

Note: The DPI 104 uses a small quantity of power while it is OFF. If you put it into storage for a long period, disconnect the battery (refer to "Installation").

To start - Menu operation

	Menu Description	Steps		Result/Subsequent steps
		1	2	
	OFF = Power supply: OFF only		-	Power goes off
	units = Set units: (A2: item 14).			Pressure value changes to the applicable units: psi, mbar, bar ...
	t OFF = Set tare: Set to On or OFF.			On > tA 00.000 : Set a tare value (Refer to Table 4)
	OFF = Monitor maximum/minimum: Set to On or OFF			Monitor function is set on or off
	OFF = Monitor a pressure switch: Set to On or OFF.			Monitor function is set on or off
	C = Calibration: To continue, set the correct calibration access code = Serial number: Last four digits.			C0 (Correct the zero offset value) > C2 (Do a two-point pressure calibration) > V2 (Do a two-point voltage calibration). Refer to "Calibration".
	A OFF = Set low/high alarm: Set to On or OFF.			On > 000.0 ↓ > 100.0 ↑ Set a value for the low and/or high alarm (0 to 105% FSO).
	OFF = Supply voltage output (Vout): Set to OFF, P-V, or US.			P-V: Vout is proportional to the pressure value on the display. Make sure the Vout scale factor is correct. US > 000.0: Set a Vout value (0 to 100%) to control an external pressure regulator. Make sure the Vout scale factor is correct.
	S 1.00 = Set Vout scale factor: A Vout adjustment.			If applicable, set a new Vout scale factor (0.01 to 9.99). Factory value = 1.00
	Au On = Set automatic power OFF: Set to On or OFF.			On > Au 15 : Set the period for automatic power OFF (1 to 99 minutes). Factory value = 15 minutes.
	L OFF = Set lock code: A menu protection facility. Set to On or OFF.			On > L 000 : Set a new lock code (If necessary). Factory code = 000.
	Sc 02 = Set scan rate: A rate to update the maximum/minimum values			Set an applicable rate (02 to 10 Hz). Factory value = 02 Hz.
	OFF = Monitor external IDOS: Set to On or OFF.			Monitor function is set on or off
	FS ↓ = Set FSO low register: To set a different range for these functions: analogue display, %, alarm.			Set a value for the low end of the range (Refer to Table 5). Factory value = Factory calibration value.
	FS ↑ = Set FSO high register: To set a different range for these functions: analogue display, %, alarm.			Set a value for the high end of the range (Refer to Table 5). Factory value = Factory calibration value.

Normal display

Installation

This section shows how to install and connect the DPI 104. Before you start:

- Read and understand the "Safety" section.
- Do not use a damaged DPI 104.

Installation - Battery **A1.2** ... **A1.3**

Use the procedures in Table 1 to install or replace the battery.

Table 1: Installation procedures - Battery

Step	Procedure
1	If applicable, set the power to off and isolate the external power supply.
2	Remove the display bezel (Figure A1.2).
3	Make sure that the o-ring [A1: item 7] and the related surfaces are serviceable. Use only original parts supplied by the manufacturer.
4	Remove the battery clamp [A1: item 10].
5	If applicable, disconnect the battery connector [A1: item 8] and *discard the used battery.
6	Attach the battery connector [A1: item 8] to the new battery.
7	Install the new battery (Figure A1.3) and re-attach the battery clamp [A1: item 10].
8	Push the display bezel [A1: item 6] back into position until it is fully engaged.

* Use an applicable recycling facility.

Installation - Position

Make sure that you attach the DPI 104 in a safe configuration that prevents unwanted stress (for example vibration, physical impact, shock, mechanical and thermal stresses).

To get the best installation position, you can turn the pressure connector (A1: item 4) and the display bezel (A1: item 6) to give the best view of the display (Figure B1). End stops set the limits in each axis.

CAUTION: To prevent damage when you are setting the best view of the display, do not use force to turn the pressure connector or the bezel farther than the end stops.

Installation - Pressure connections

CAUTION: To prevent damage, do not use the body of the DPI 104 to tighten the pressure connection. Use the flat faces on the pressure connector.

Use an applicable method to seal the pressure connections, and then tighten to the applicable torque (Figure 1 and Table 2).



a) 1/4 NPT:
Pressure < 1000 bar (15000 psi)



b) G1/4:
Pressure < 1000 bar (15000 psi)



c) 9/16 x 18 UNF cone:
Pressure ≥ 1000 bar (15000 psi)

Figure 1: Connection methods

Table 2: Key to figure 1

Item	Description
1.	Applicable DPI 104 pressure connector. Maximum torque: 1/4 NPT: 68 Nm (50 lbf.ft) G1/4: 20 Nm (15 lbf.ft) 9/16 x 18 UNF cone: 34 Nm (25 lbf.ft)
2.	(1/4 NPT only) Thread with an applicable sealant
3.	(G1/4 only) Applicable bonded seal

Installation - Electrical connections

The DPI 104 includes an 8-pin electrical connector (A1: item 1). Table 3 shows the pin connections.

Table 3: Connections for the 8-Pin connector

Connector	Pin	Input/Output	Description
	1.	Input	12- 24V dc power supply
	2.	Input	Signal ground
	3.	Output	RS232 transmit
	4.	Input	RS232 receive
	5.	Output	Voltage output
	6.	Output	Alarm output
	7.	Input	Pressure switch input
	8.	Output	No connection

These optional accessories use the connector:

- RS232 PC connection
 - external IDOS UPM connection + power supply adaptor
- Note: Use only original parts supplied by the manufacturer.*

You can also use the RS232 interface to make a serial network of units (maximum: 99). Refer to "Operation - Set up a DPI 104 network".

Electrical connections - External power

We recommend you use an external power supply for these functions and operations:

- Functions: Maximum/minimum, Switch, Low/high alarm, Vout, IDOS
- Operations that use the DPI 104 for long periods

Operation

This section shows how to use the DPI 104. Before you start:

- Read and understand the "Safety" section.
- Make sure that the installation is complete (Refer to the "Installation" section).
- Do not use a damaged DPI 104.

Operation - Menu: Set units

There are 11 different units to measure pressure. Refer to the "Specification data" section.

Units - Set up

Refer to "To start - Menu operation".

Operation - Menu: Set tare

Use the tare function to adjust the pressure value on the display. For example: To make an adjustment for atmospheric pressure. Refer to Table 4.

Table 4: Permitted tare values

Range	Permitted tare values
g: 0.7 bar (10 psi)	-0.7 bar (-10 psi) to 105% FS
a, sg, g: ≥ 2 bar (30 psi)	-1 bar (-15 psi) to 105% FS

If you set a value that is not in the permitted range, the value is rejected and the number entry prompt reverts to the last accepted value.

Tare - Set up and use

Menu: Set this function to *On* (Refer to "To start - Menu operation").

When this function is *On*, there are two options to set a tare value (tA):

- **Menu option:** Set the menu "t On", then set a tA value:

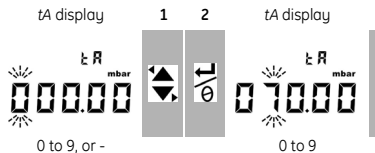

Repeat steps **1 + 2** for each digit and for the decimal point.

- **Zero option:** Step **1** lets you set a value for tA. Press and hold.

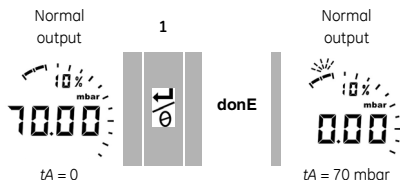

When tA is not zero, the last segment on the analogue dial flashes.

To make sure that there is an indication of the correct pressure while tare is *On*, the analogue dial and % indication show values calculated from the calibrated range without the tare adjustment.

Tare - With Lock

If the menu lock is *On* with a lock code set < 500, the zero option is rejected - Error code (E0002).

Tare - With Alarm and/or Vout

If you set a tare value (tA) while the alarm and/or Vout functions are *On*, the display counts down from: tArE9 to tArE0.

If the tA value is set, the alarm and Vout functions start to use values calculated from the calibrated range.

 To cancel the specified tA value, press this button.

 To continue with the specified tA value, press this button OR let the count complete.

Tare - With FSO values

To make sure that there is an indication of the correct pressure while tare is *On*, the FSO Low and/or FSO High values are not used.

Operation - Menu: Monitor maximum/minimum

When this function is *On*, it updates its data at five times the specified scan rate (02 to 10 Hz). Refer to "To start - Menu operation".

To save battery power, we recommend that you use an external power supply with this function.

Maximum/minimum - Set up and use

Menu: Set this function to *On* (Refer to "To start - Menu operation").

When this function is *On*, use steps **1 + 2** to show the maximum/minimum since the last reset.

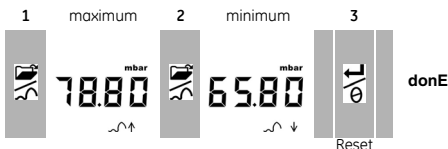

Step **3** lets you reset the values for maximum/ minimum. Press and hold.

Operation - Menu: **Monitor a pressure switch**

Use this function to measure the performance of a pressure switch (mechanical operation and hysteresis). To save battery power, we recommend that you use an external power supply with this function.

Pressure switch input - Set up and use

1. Connect the instrument (Figure 2/Table 3).
2. Menu: Set this function to *On* (Refer to "To start - Menu operation").

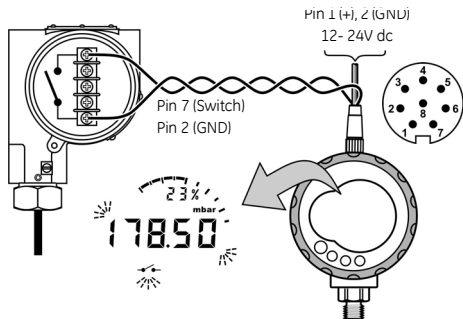

Figure 2: Example configuration - Switch input

Figure 2 shows the display when the switch condition changes (open or closed). The analogue dial and the % indication continue to monitor the normal pressure. The switch symbol and the value on the main display flash to give the switch condition and the switch pressure.

To reset the monitor function, press this button.

Operation - Menu: **Calibration**

Refer to the "Calibration" section.

Operation - Menu: **Set low/high alarm**

Use the alarm function to show when the pressure is not in the specified limits for the system.

Set applicable values in the range 0 to 105% FSO:

$$\%FSO = [\text{Applied Pressure} / (\text{FSO High} - \text{FSO Low})] * 100$$

Note: If you set a tare value, the alarm function uses the calibrated range (Refer to "Operation - Menu: Set tare").

The alarm indication is available on the display and as a signal output (Table 3).

While there is an alarm condition, the applicable alarm symbol (high or low) flashes on the display (A1: Item 15). To save battery power, we recommend that you use an external power supply with this function.

Low/high alarm - Set up and use

Menu: Set this function to *On* (Refer to "To start - Menu operation"). Then use these steps to set the low and/or high alarm.

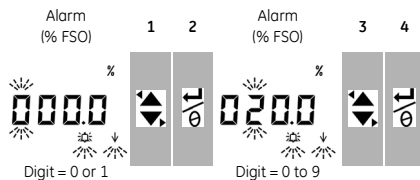

5. To finish, repeat steps 3 + 4 for each digit. If the value you enter is not correct, the value resets to the nearest permitted value. That is:
 - a value in the range 0 to 105% FSO
 - a low alarm value < high alarm value
 To accept or change the new value, repeat steps 1 to 5.

To cancel the new value, press this button.

Operation - Menu: **Supply voltage output (Vout)**

Use the Vout function to supply a voltage output (0 to 5V) to an external system. There are two options:

P-V: Vout is proportional to the pressure value on the display.

US: *User mode.* Set a value in the Vout register (0 to 100%) to control an external pressure regulator.

To save battery power, we recommend that you use an external power supply with this function.

P-V mode voltage calculation

Example DPI 104: FSO = 20 bar (or 300 psi), Vout scale factor = 1.00.

If you apply 10 bar (or 150 psi) to this DPI 104:

$$V_{out} = (10/20 * 5V) / 1.0 \text{ OR } (150/300 * 5V) / 1.0 = 2.5V$$

US mode voltage calculation

This calculation uses the values set up for the Vout register and the Vout scale factor.

If the pressure ranges for the DPI 104 and the regulator are different, set a new Vout scale factor (refer to "Operation - Menu: Set Vout scale factor").

$$V_{out} = \left[\frac{(\text{Vout register} / 100) * 5V}{\text{Vout scale factor}} \right]$$

Example if the Vout register is set to 25%, and the Vout scale factor is set to 0.5:

$$V_{out} = (25/100 * 5V) / 0.5 = 2.5V$$

Voltage output (Vout) - Set up and use

1. Connect the instrument (Figure 3).
2. Menu: Set this function to *OFF*, *P-V*, *US* (Refer to "To start - Menu operation").

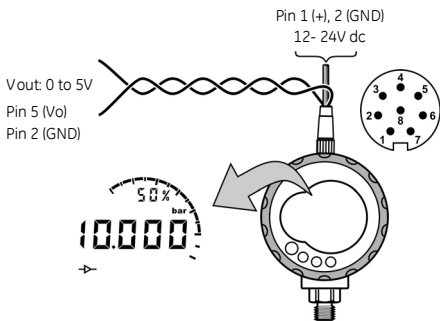

Figure 3: Example configuration: Vout

Operation - Menu: Set Vout scale factor

When the Vout function is set to P-V or US mode, the Vout scale factor becomes part of the Vout calculation (refer to "Operation - Menu: Supply voltage output (Vout)").

If the pressure ranges for the DPI 104 and the external pressure regulator are different, you must set an applicable scale factor (0.01 to 9.99).

Example - To get a 25 bar (or a 375 psi) line pressure with:

- an External pressure regulator:
FSO = 100 bar (or 1500 psi)
- a DPI 104: FSO = 200 bar (or 3000 psi)

In this example:

$$\text{Scale factor} = 100/200 \text{ OR } 1500/3000 = 0.5$$

$$\begin{aligned} \text{Vout register (\%)} &= (25/200) * 100 \text{ OR } (375/3000) * 100 \\ (\text{DPI 104}) &= 12.5\% \end{aligned}$$

To get a 25 bar (or a 375 psi) line pressure, the DPI 104 uses these values to supply the Vout value shown below:

$$\text{Vout} = (12.5/100 * 5V) / 0.5 = 1.25 \text{ V}$$

Operation - Menu: Set automatic power OFF

Use this function to save battery power. The power goes off a specified period after the last button or external software operation. To get the maximum battery life, we recommend you use this function.

Note: The DPI 104 uses a small quantity of power while it is OFF. If you put it into storage for a long period, disconnect the battery (refer to "Installation").

Automatic power OFF - Set up and use

Menu: Set this function to On. Then set an applicable value in the range 1 to 99 minutes. Refer to "To start - Menu operation".

Note: If continuous operation is important, set this function to OFF and use an external power supply.

Operation - Menu: Set lock code

Use the lock function to prevent accidental changes to the configuration. There are two options:

- Lock code < 500: This locks the menu and the tare function. Factory code = 000
- Lock code > 499: This locks the menu but you can still use the zero option to set a tare value.

Refer to "Operation - Menu: Set tare".

Lock code - Set up and use

Menu: Set this function to On (Refer to "To start - Menu operation"). Then use these steps to set a new code.

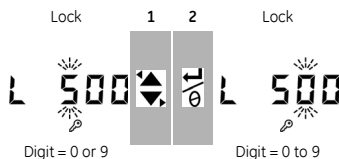

3. To finish the lock code, repeat steps 1 + 2 for each digit. The next time you want to change the menu options, the display shows: L - - -

Enter the applicable code. To reset the code to the factory code, you must do a restore operation. Refer to "Maintenance".

Operation - Menu: Set scan rate

Use the scan rate function to set the rate used to update the maximum/minimum values.

Note: When you increase the scan rate, you increase the power consumption. The maximum/minimum function updates its data at five times the specified scan rate.

The rate for the normal pressure display is always 2 Hz.

Scan rate - Set up and use

Menu: Set an applicable value in the range 2 to 10 Hz. Refer to "To start - Menu operation".

Operation - Menu: Monitor external IDOS

Use this function to read the pressure from an external IDOS UPM. The calibration function is not available but you can use all the other DPI 104 pressure functions. Example: Set tare, Monitor maximum/minimum.

This function does not supply power to the IDOS UPM. To use it, you must have the optional external IDOS UPM connection + power supply. This optional accessory uses the RS232 connections in the 8-pin connector (Table 3).

Monitor external IDOS - Set up and use

1. Connect the instrument (Figure B2).
2. Menu: Set this function to On (Refer to "To start - Menu operation").
3. If necessary, set the applicable additional functions specified in this manual.

Operation - Menu: Set FSO low/high registers

Use the FSO low/high registers to set a different range for these functions: analogue display, % indication, low/high alarm.

Initially, these register values are set to the factory calibration values. Example:

Calibrated range: 0.7 bar (10 psi) gauge.

Selected units: mbar

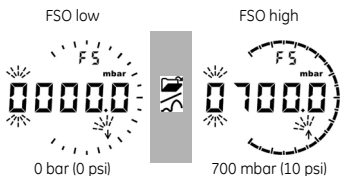

Table 5 gives the permitted alternative values you can use.

Table 5: Permitted FSO values

Range	Permitted FSO values
All ranges: a, sg	0 to 105% FS
g: 0.7 bar (10 psi)	-0.7 bar (-10 psi) to 105% FS
g: ≥ 2 bar (30 psi)	-1 bar (-15 psi) to 105% FS
All ranges	FSO low < FSO high

FSO low/high registers - Set up and use

Menu: Set the menu option to the FSO low register (Refer to "To start - Menu operation"). Then use these steps to set an applicable value in the permitted range (Table 5):

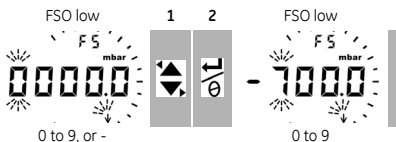

3. Repeat steps 1 + 2 for each digit and for the decimal point.

If the value you enter is not correct, the value resets to the nearest permitted value (Table 5).

To accept or change the new value, repeat steps 1 to 3.

To cancel the new value, press this button.

4. If necessary, repeat the procedure for the FSO high register.

Operation - Set up a DPI 104 network

You can set up a network of up to 99 units in series ('daisy chain'). Figure 4 shows the electrical connections to do this (Refer to Table 3).

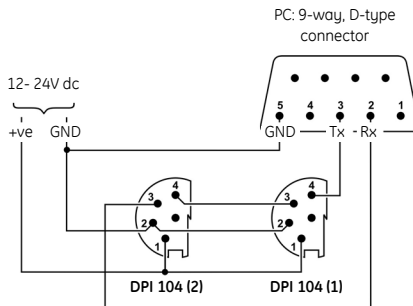

Figure 4: Connections for a DPI 104 network

Operation - Error indications

Table 6: Error codes/indications

Code	Description
E0001	Incorrect unlock code. Use the correct code.
E0002	The tare facility is not available because the menu lock is On and the lock code < 500. Change the menu configuration.
E0004	Start up error. Do a restore operation (Refer to "Maintenance").
E0005	External IDOS UPM not found. Make sure that all the related equipment and connections are serviceable.
E0006	Incorrect calibration access code. Use the correct code.
E0007	The power supply is too low to do a calibration. Use an external power supply or replace the battery.
E0009	Unable to supply the specified Vout. Example: <ul style="list-style-type: none"> Low battery. Use an external power supply or replace the battery. Bad connection. Make sure that all the related equipment and connections are serviceable.
OLoAd	Applied pressure ≥ 110% FS. Reduce the pressure.
99999/-9999	There are not enough digits in the main display to give the correct pressure value. Change the measurement units.

Maintenance

Clean the case with a moist, lint-free cloth and a weak detergent. Do not use solvents or abrasive materials. Make sure that there is no damage to the threads and O-rings, and that they are free of grit and other obstructions.

You must return the unit to the supplier for all repairs.

Maintenance – Replace the batteries

To replace the batteries, refer to "Installation". All the configuration options stay in memory.

Maintenance – Restore the original configuration

If it is necessary to restore the unit to the original factory configuration, press and hold all four buttons until the display goes off (= five seconds). The unit then restarts.

"To start - Menu operation" shows the factory settings. The lock code is reset to the factory code (000).

Calibration

Note: GE can provide a calibration service that is traceable to international standards.

We recommend that you return the DPI 104 to the manufacturer or an approved service agent for calibration.

If you use an alternative calibration facility, make sure that it uses these standards.

Calibration - Equipment and conditions

To do an accurate calibration, you must have:

- the calibration equipment specified in Table 7.
- a stable temperature environment: 20 ± 1°C (68 ± 2°F)

Table 7: Calibration equipment

Function	Calibration equipment
Pressure	An applicable pressure standard (primary or secondary) with a total uncertainty of 0.01% reading or better. Make the pressure connection to A1 - item 4. Refer to "Installation".
Volts (V)	Volts calibrator. Accuracy: 0.025% reading or better. Make the Vout connection to A1 - item 1. Refer to "Installation"

Calibration - Procedures

1. Connect the applicable calibration equipment (Table 7).
2. Menu: Set the menu option to C _____. Then set the calibration access code = last four digits of the serial number (Refer to "To start - Menu operation").

There are three calibration options (Table 8):

Table 8: Calibration options

Option	Description
C0:	Set the necessary offset value for the instrument to give the correct pressure related to zero: All ranges g or sg: Zero (bar/psi); Ranges a: Ambient pressure*
C2:	Do a two-point pressure calibration. All ranges g or sg: P1 = Zero (bar/psi); P2* = FS Ranges a: P1* = Ambient pressure; P2* = FS
V2:	Do a two-point voltage calibration. All ranges: P1** = 0.1000 V; P2** = 5.0000 V

* adjustable by 5% FS; ** adjustable by 50 mV



To move to the next option without a change to the values, press this button.



To stop and make changes to a value, press this button.



To return to the normal display, wait eight seconds.

Calibration - C0 (Zero offset)

The DPI 104 shows these displays:

1. The calibration point to be used for C0. This value is only adjustable for an absolute type DPI 104 (Table 8).
C0 - Gauge = 0000.0

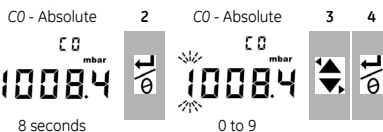

5. Repeat steps 3 + 4 for each digit and for the decimal point. The value is ignored if it is not in the permitted limits (Table 8).

This value is then used as the Set Point (SP) on the subsequent displays.

6. This sequence of displays will follow:

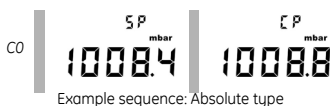

The SP value is followed by the measured pressure - Current Pressure (CP). This sequence continues until you accept or reject the offset value.

7. When the pressure is stable:



To accept the new offset value, press this button.



The display shows "done", and then the next calibration option (C2).



To reject the new offset value and move to the next calibration option (C2), press this button.

The value is ignored if it is not in the permitted limits (5% FS) or if the CP value is not stable.

Calibration - C2 (two-point pressure calibration)

Point 1 (P1) - The DPI 104 shows these displays:

1. The calibration point to be used for C2 - Point 1. This value is only adjustable for an absolute type DPI 104 (Table 8). C2 - Point 1 (Gauge) = 0000.0

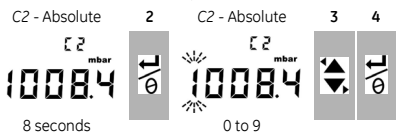

5. Repeat steps 3 + 4 for each digit and for the decimal point. The value is ignored if it is not in the permitted limits (Table 8).

This value is then used as the Set Point (SP) for point 1 on the subsequent displays.

6. This sequence of displays will follow:

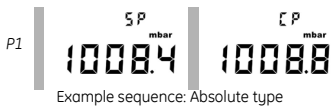

Example sequence: Absolute type

The SP value is followed by the measured pressure - CP. This sequence continues until you accept or reject the point 1 value.

7. When the pressure is stable:

- To accept the new P1 value, press this button. The display shows the calibration point C2 - point 2 (C2).
- To reject the new P1 value and move to the next calibration option (V2), press this button.

The value is ignored if it is not in the permitted limits (5% FS) or if the CP value is not stable.

Point 2 (P2) - Use the same steps (1 to 5 above) to set C2 - Point 2. This is the FS value and it is adjustable for the absolute and gauge type DPI 104 (Table 8).

6. This sequence of displays will follow:

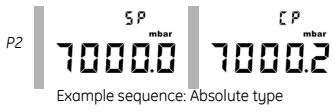

Example sequence: Absolute type

The SP value is followed by the measured pressure - CP. This sequence continues until you accept or reject the point 2 value.

7. When the pressure is stable:

- To accept the new P2 value, press this button. The display shows "donE", and does a two-point calibration. The instrument then restarts.
- To reject the new P2 value and move to the next calibration option (V2), press this button.

The value is ignored if it is not in the permitted limits (5% FS) or if the CP value is not stable.

Calibration - V2 (two-point voltage calibration)

Point 1 (P1) - The DPI 104 shows these displays:

1. The calibration point to be used for V2 - Point 1.

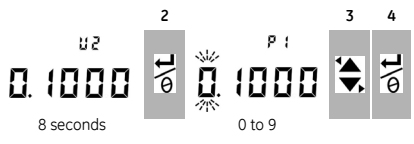

After step 2, the DPI 104 sets Vout to 0.1 V. Correct the value (P1) to the value shown on the voltage calibrator.

5. Repeat steps 3 + 4 for each digit. The value is ignored if it is not in the permitted limits (Table 8).

Point 2 (P2) - If P1 has a permitted value, the DPI 104 shows these displays:

1. The calibration point to be used for V2 - Point 2.

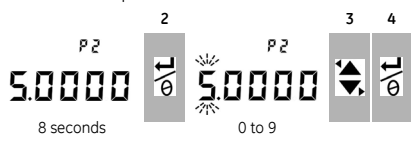

After step 2, the DPI 104 sets Vout to 5.0 V. Correct the value (P2) to the value shown on the voltage calibrator.

5. Repeat steps 3 + 4 for each digit. The value is ignored if it is not in the permitted limits (Table 8).

6. If P2 has a permitted value, the DPI 104 uses the new P1/P2 values to adjust the output (Vt):



- To accept the V2 calibration, press this button. The display shows "donE". The instrument then restarts.
- To reject the V2 calibration and move to the next menu option, press this button.

Specification data

Specification - General

Operating temperature	-10 to 50°C (14 to 122°F)
Storage temperature	-20 to 70°C (-4 to 158°F)
Ingress Protection	IP65 (Dust-tight, jets of water)
Materials	Case: Acrylonitrile Butadiene Styrene (ABS) Refer also to <i>Media notes</i> .
Humidity	0 to 95% without condensation (Def Stan 66-31, 8.6 cat III)
Shock/Vibration	BS EN 61010:2001; Def Stan 66-31, 8.4 cat III
EMC	BS EN 61326-1:1998 + A2:2001
Safety	Electrical - BS EN 61010:2001; Pressure Equipment Directive - Class: Sound Engineering Practice (SEP);
Approved	CE Marked
Size	Diameter = 95 mm (3.74 in); Depth = 55 mm (2.2 in) Typical length (with connector) = 120 mm (4.7 in)
Weight	350 g (12.5 oz)
Power supply	9V, Alkaline (MN1604) - Supplied; OR Use an external 12-24 V dc supply <i>Note: For maximum battery life, use a 9V, Li (MN1604).</i>
Battery life	Up to one year for pressure measurements; Au (power save facility) - On; maximum/minimum, alarm, Vout, switch - All set to OFF

Specification - Pressure measurement

Range: gauge (g), absolute (a), sealed gauge (sg)			Resolution		Maximum Working Pressure (MWP)		Media notes
bar*	psi*	Type	mbar	psi	bar	psi	
(-0.7) 0 to 0.7	(-10.0) 0 to 10	g*	0.01	0.001	0.77	11.2	1
(-1.0) 0 to 2.0	(-15.0) 0 to 30	g* or a	0.1	0.001	2.2	32	1
(-1.0) 0 to 7.0	(-15.0) 0 to 100	g* or a	0.1	0.01	7.7	111.7	2
(-1.0) 0 to 20	(-15.0) 0 to 300	g* or a	1	0.01	22	319	2
(-1.0) 0 to 70	(-15.0) 0 to 1000	g* or a	1	0.1	77	1117	2
0 to 200	0 to 3000	sg	10	0.1	220	3190	2
0 to 350	0 to 5000	sg	10	0.1	385	5583	2
0 to 700	0 to 10000	sg	10	1	770	11165	2
0 to 1000	0 to 15000	sg	100	1	1100	15950	3
0 to 1400	0 to 20000	sg	100	1	1540	22330	3

* Negative ranges shown in (...) - gauge units only.
Media notes:
1. Non-corrosive, non-conductive liquid or Non-corrosive, dry gas
2. Media applicable to stainless steel (316)
3. Media applicable to Inconel 625

Accuracy (0 to FS)	0.7 bar (10 psi): 0.15% FS All ranges ≥ 2 bar (30 psi): 0.05% FS
Units	kPa, MPa, kg/cm ² , psi, mbar, bar, mmHg, mmH ₂ O, mH ₂ O, inH ₂ O, inHg
Pressure connections	Ranges ≤ 700 bar (10000 psi): 1/4 NPT male OR G1/4 male Ranges > 700 bar (10000 psi): 9/16 x 18 male cone

Specification - Electrical

Switch input	Maximum impedance: 200Ω (mechanical contact only)
Alarm output	Type: Open drain Field Effect Transistor (FET) Maximum (mA): 250 mA; Maximum (V): 24 V dc
Analogue output	0 to 5 V dc; Minimum load: 500 Ω; Maximum zero offset error: 50 mV Accuracy: 0.1% FS at 20°C (68°F) - User mode only. Temperature coefficient: 0.007% FS / °C (0.0039% FS / °F)
RS232/Network capacity	For: IDOS UPM, external software, or up to 99 units in series ('daisy chain').

Customer Service

Visit our web site: www.gesensing.com